

# **WARNING:** AVOID SERIOUS INJURY FROM FALLING OR SLIDING OUT. ALWAYS USE RESTRAINT SYSTEM.

Your child's safety depends on you. Proper stroller usage cannot be assured unless you follow these instructions.

**DO NOT USE STROLLER UNTIL YOU READ AND FOLLOW THE MANUFACTURER'S INSTRUCTIONS.**

### **IMPORTANT SAFETY INFORMATION:**

- **NEVER LEAVE YOUR CHILD UNATTENDED WHILE IN STROLLER.**  
Accidents can happen quickly while your back is turned. You must always keep your child in view while your child is in the stroller, even when sleeping. Your child may become tangled in straps or pads and suffocate.
- **Always use restraint system to keep child from standing up or falling out of the stroller. Use this harness at all times.**
- **Do not use any infant car seat with this stroller. Serious injury may occur.**
- **THIS IS NOT AN EXERCISE STROLLER!** Do not use this product while running, jogging, in-line skating or participating in other athletic activities.
- **Always balance the weight of the stroller evenly.** To prevent the stroller from becoming unstable or tipping:
  - Do not place parcels or accessory items on the stroller canopy, seat, or over the handle.
  - Do not put more than 10 lbs (4.54 kg) in the basket.
  - Do not put more than 3 lbs (1.362 kg) in each Saddle Bag.
  - Do not allow children to play with or hang onto the stroller.
- **Always lock the stroller open before allowing your child in or near the stroller.** This prevents injuries caused by stroller collapsing.
- **Only use this stroller with children who weigh less than 45 lbs (20.43 kg) & who's head rests below the top of the seat back.** Use by larger children may damage the stroller, or cause a hazardous unstable condition to exist.
- **Only use this stroller in recline position until child can sit up unassisted.**
- **Put on all brakes whenever you park the stroller, especially on an incline.** This prevents the stroller from rolling away.
- **Never use this stroller on stairways or escalators.**
- **Do not allow child to stand on seat or sit on footrest.**
- **Always fasten the hood onto the seat back when using the stroller in the reclined position.**
- **Do not lift by tray or toys.**
- Do not allow children to climb into stroller unassisted. Stroller may tip over and injure child.
- Keep wheels at a recommended tire pressure of 35 p.s.i. (241 kPa).
- Only use replacement parts supplied by the manufacturer.
- **Do not carry extra children or use accessories other than those approved by the vehicle manufacturer.**
- **The stroller should not be used near an open fire or exposed flame.**
- **Make sure children are clear of any moving parts if you adjust the stroller, otherwise they may be injured.**

# How to Assemble Your Stroller

## 1 TO OPEN STROLLER:

**Step 1.** Release locking latch. (Figure A).

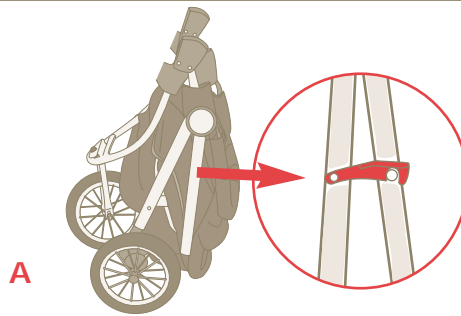

**Step 2.** Unfold as shown. Make sure both locks snap into place. (Figure B).

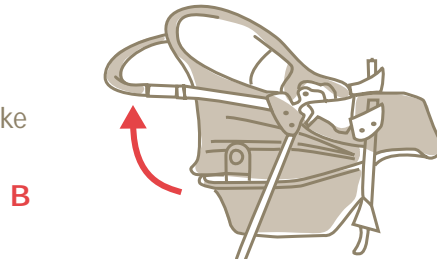

## 2 TO ASSEMBLE REAR TIRES:

**Step 1.** Remove and discard protective plastic sleeve from ends of rear axle assembly.

**Step 2.** Position rear axle assembly as shown (Figure A), with brake levers pointing towards stroller handle.

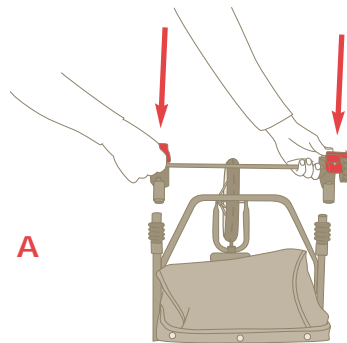

**Step 3.** Push both brake assemblies onto rear leg tubes at the same time until spring loaded buttons click into place (Figure B).

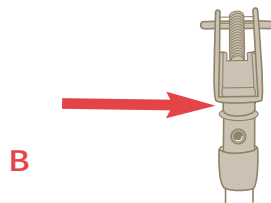

**Step 4.** Lay stroller on its side. Slide wheel onto axle. (Figure C).

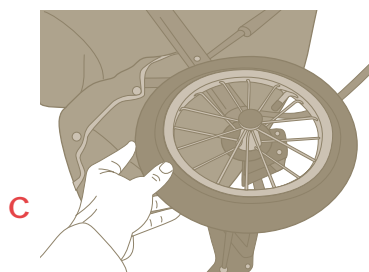

**Step 5.** Push down on wheel until you hear a click. **Pull up on wheel to make sure it is properly secured.** If wheel pulls off, push wheel onto axle again but push metal clip in at the same time. Make sure wheel is secure (Figure D).

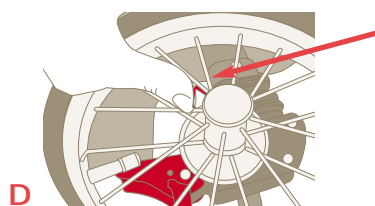

**Step 6.** Repeat for second side.

**To Remove Wheel.** Press metal clip in and pull wheel off.

**NOTE:** Keep wheels at a recommended tire pressure of 35 p.s.i. (241 kPa).

### 3 TO ATTACH FOOTREST:

**Step 1.** Align and place footrest against stroller frame as shown making sure notch in footrest fits over metal rod that supports seat (Figure A).

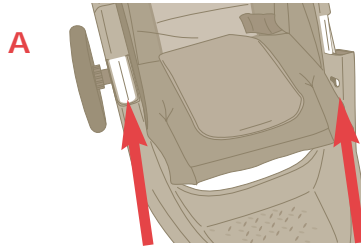

**Step 2.** Place stroller back on handle bar (Figure B).

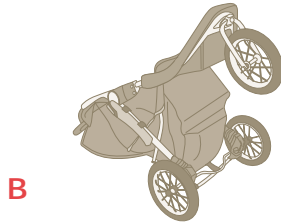

**Step 3.** Align bosses on footrest to the two holes on the metal frame over front wheel (Figure C). Feed bosses through holes.

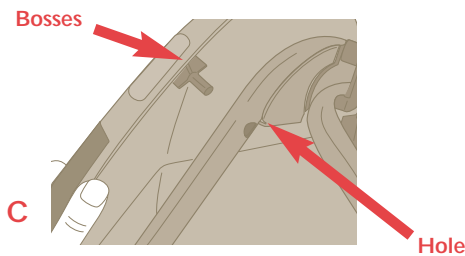

**Step 4.** Secure footrest to frame with screws using a Phillips screwdriver (Figure D). Repeat for second side.

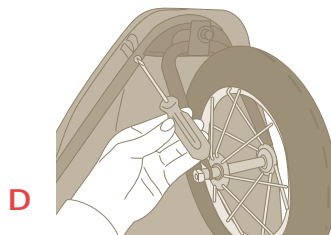

**Step 5.** Loop straps of basket through slots in footrest as shown to secure (Figure E).

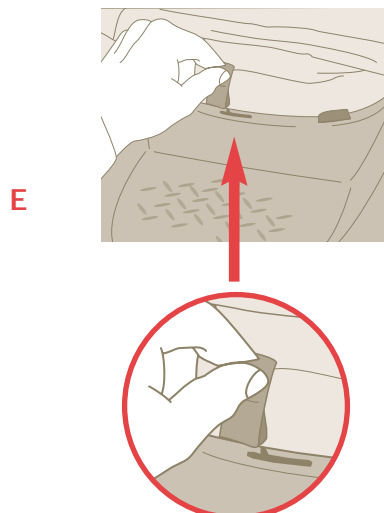

## 4 TO ATTACH SADDLE BAGS:

**Step 1.** To attach saddle bags, feed & secure one end of Velcro strap through footrest. (Figure A).

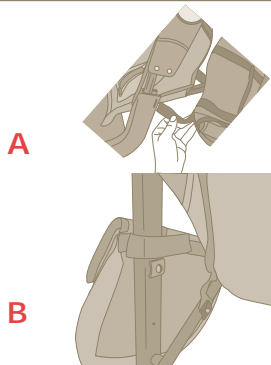

**Step 2.** Feed and secure other end of velcro strap through metal clip on oval tubing. (Figure B).

**⚠ WARNING! ⚠**  
DO NOT PUT MORE THAN 3 LBS  
(1.362 KG) IN EACH SADDLE BAG.

## 5 TO ATTACH FRONT TRAY:

**Step 1.** Place tray onto metal tubing between footrest and side housing.

**Step 2.** Snap tab in place.

**Step 3.** Repeat for second side.

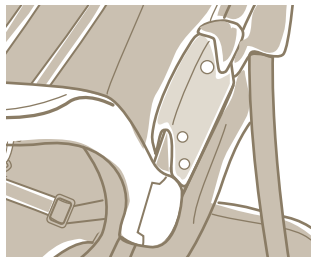

## 6 TO ASSEMBLE ELECTRONIC TOYS (SELECT MODELS):

**Step 1.** Attach mirror to toys as shown.

**Caution:** For your child's safety, remove the following labels if found on this toy before use:

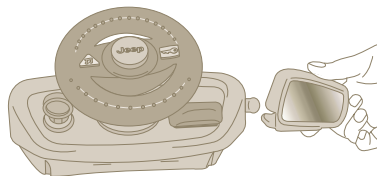

- "Try Me" on front of unit.
- Protective film on mirror.

## 7 TO INSTALL BATTERIES IN ELECTRONIC TOYS (SELECT MODELS):

**Step 1.** To insert batteries, use a phillips head screwdriver to unfasten battery cover. Insert batteries as shown. Requires 2 "AA" batteries (Not Included). Secure battery cover.

**Step 2.** Turn switch on "1" to play sounds. To turn off, move switch to "0".

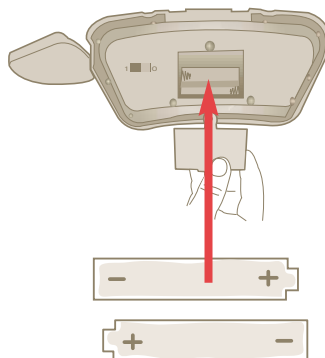

### ⚠ CAUTION ⚠

Old and new batteries should not be mixed. Different type batteries should not be mixed. Remove batteries before storing the toys.

## 8 TO ATTACH ELECTRONIC TOYS (SELECT MODELS):

**Step 1.** Place electronic toys so that they face the child in the stroller.

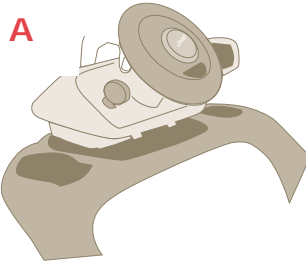

**Step 2.** Tilt toys toward stroller and align tabs with rear tray slots. Lock tabs into slots (Figure A).

**Step 3.** Press down firmly on front of toys until front tabs lock toys securely in place (Figure B).

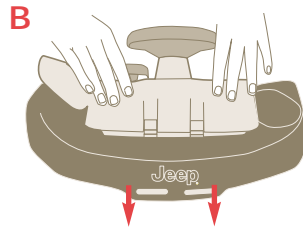

**Step 4.** To remove toys from tray, press down on front tabs to release front tabs and pull up on toys.

## 9 TO ATTACH NON ELECTRONIC TOYS (SELECT MODELS):

**Step 1.** Position toy steering wheel on snack tray as shown. (Figure A).

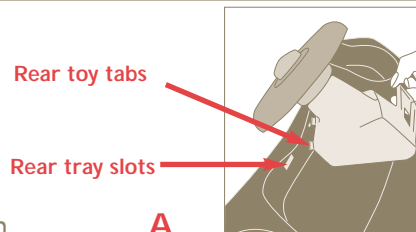

**Step 2.** Align rear toy tabs with rear tray slots. Hook into place.



**Step 3.** Place your thumbs underneath tray and with fingers, snap front portion of toy steering wheel into front tray slots. (Figure B).

**Step 4.** To remove toys, press plastic tabs on front of toy steering wheel and pull up. (Figure C).

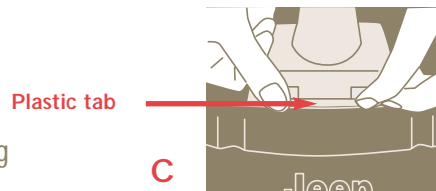

## 10 TO ATTACH PARENT TRAY (SELECT MODELS):



DO NOT PLACE MORE THAN 3 LBS. (1.362 KG) IN THIS TRAY TO AVOID TIPPING!

DO NOT PLACE HOT LIQUIDS IN THIS TRAY. HOT LIQUIDS CAN BURN YOUR CHILD.

**Step 1.** Align tray holes with posts near handle and snap on.

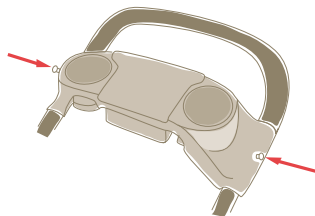

**Step 2.** To remove, pull each side up and out. For cleaning, parent tray is top rack dishwasher safe.

# How to Properly Use Your New Stroller

## 1 TO SECURE CHILD IN STROLLER:

### **WARNING!**

AVOID SERIOUS INJURY FROM FALLING OR SLIDING OUT.  
USE THIS HARNESS AT ALL TIMES.

Lock all foot brakes to keep stroller from rolling.

**Step 1.** Place child in stroller.

**Step 2.** Hook shoulder straps to waist belt.

**Step 3.** To secure, snap each side of waist belt into buckle. (Figure A).

To release, press tabs and pull apart.

**Step 4.** For proper fit, adjust shoulder straps and waist band as shown. (Figure B).

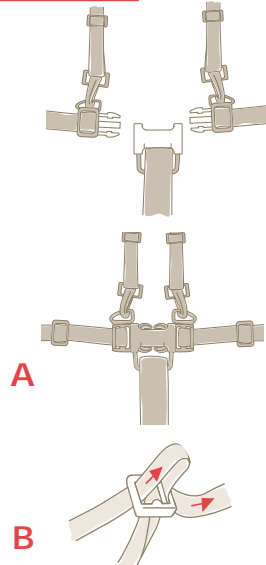

Adjust restraint system harness

## 2 TO RECLINE SEAT (YOUR STROLLER WILL RECLINE IN 1 OF 2 WAYS):

### **WARNING:**

- TO AVOID FINGER ENTRAPMENT OR PINCHING, DO NOT ADJUST THE SEAT BACK WHILE CHILD IS IN THE STROLLER.
- TO AVOID HEAD ENTRAPMENT, ALWAYS FASTEN CANOPY TO SEAT BACK WHEN USING REAR SEAT IN RECLINED POSITION.

**Step 1.** To recline seat, loosen belt.

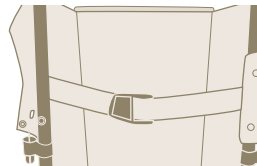

**Step 2.** To raise seat back, tighten belt.



OR

**Step 1.** Pull adjustment ring down to recline seat back.

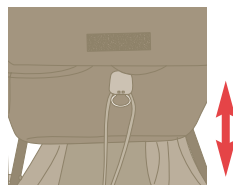

**Step 2.** Hold drawstrings down & push adjustment ring up.

## 3 TO OPERATE BRAKES:

**Lock Brake.** Push 1-Touch braking bar down at any location to lock wheels.

**Unlock Brake.** Lift up on braking bar to release.

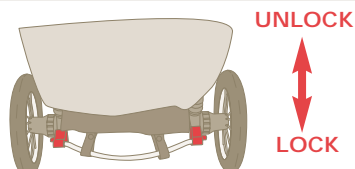

## 4 SWIVEL WHEEL LOCK (SELECT MODELS):

**Lock Front Swivel.** Adjust front wheel so that wheel is straight and lock is forward. Push lock to right.

**Unlock Front Swivel.** Push lock to left.

**NOTE:** On rough surfaces, lock the wheel to keep straight. On smooth surfaces, unlock to allow the wheel to swivel.

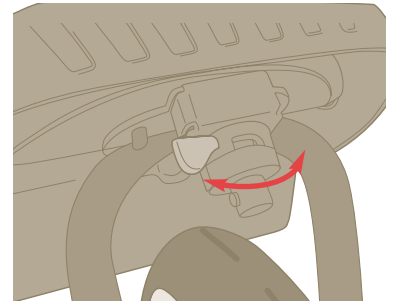

## 5 AIR PUMP USE & STORAGE

**CAUTION**  
KEEP WHEELS AT A RECOMMENDED  
TIRE PRESSURE OF 35 P.S.I. (241 kPa).

To use the air pump

**Step 1.** Remove air pump from storage pocket on back stroller

**Step 2.** Remove air tube from pump. (Figure A)

**Step 3.** Screw air tube to opposite end of pump. (Figure B)

**Step 4.** Attach air pump to fill-tube on tire.

**Step 5.** Pump air pump until tires are filled to 35 PSI (241 kPa).

**Step 6.** Disassemble pump and store in pocket when not in use.

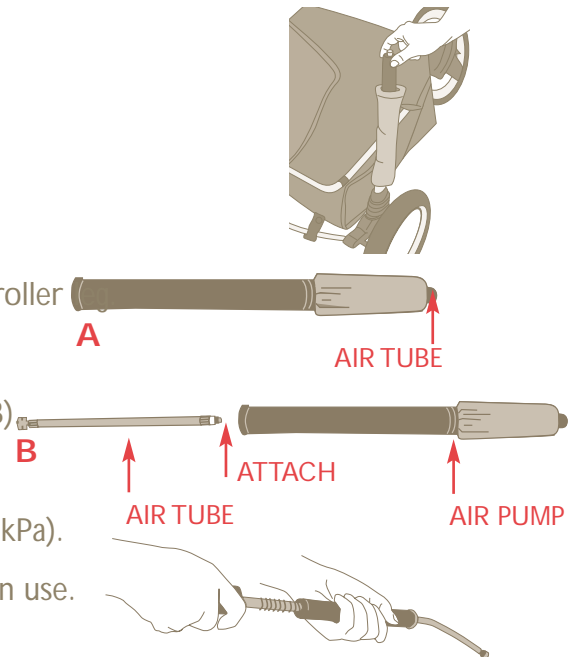

## 6 TO FOLD STROLLER:

**Step 1.** Lock brakes.

**Step 2.** Recline seat.

**Step 3.** Close canopy.

**Step 4.** **4a** Push red button to left with thumb to unlock position **4b** then squeeze large red lever on handle to fold stroller.

**NOTE:** If 1-hand fold feature does not operate properly, pull up latches on frame to fold. (Figure C).

**Step 5.** Push stroller down to fold stroller.

**Step 6.** Engage locking latch. (Figure D).

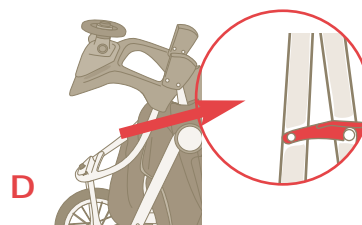
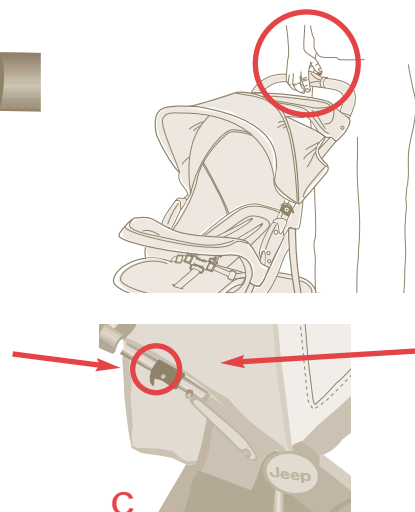

## CARE / MAINTENANCE

- Always store your Jeep® baby product in a clean dry place. If exposed to damp conditions, leave fully opened and in a warm environment. Dry off with a soft cloth. Storing a damp stroller will encourage mildew to form.
- Do not leave in the boot of a car.
- Avoid exposure to salt water/seat water, as this may encourage the formation of rust. If stroller is used in this environment, completely clean your stroller afterwards to remove sand and salt from mechanisms and wheel assemblies.
- Should parts of your stroller become stiff, squeak or difficult to operate ensure dirt is not the cause. To keep your stroller running smoothly and avoid squeaking wheels use a silicone, graphite based lubricant or 3-in-1 oil (like motor oil). It is important to get the lubricant into the axle and the wheel assembly. **DO NOT** over lubricate or use WD-40, as this will encourage the accumulation of dirt.
- Clean metal parts with a damp cloth and wipe dry.
- Clean woven fabric or vinyl parts with mild soap and water solution.
- Dry wet stroller with a soft cloth to prevent rusting.
- When storing stroller, never stack other items on top of it; this may damage the stroller.
- Periodically check for worn parts, loose screws, torn materials or stitching.
- Replace any damaged parts immediately.

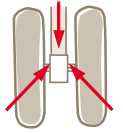

## LIMITED WARRANTY

Jeep® is a registered trademark of DaimlerChrysler Corporation, and is used under license by Kolcraft®. © DaimlerChrysler Corporation 2003  
KOLCRAFT® warrants this product to be free of defects in materials and workmanship, as follows: For a period of ONE YEAR from the date of purchase, KOLCRAFT will repair or replace, at its option, the defective product.

REPAIR OR REPLACEMENT AS PROVIDED UNDER THIS WARRANTY IS THE EXCLUSIVE REMEDY OF THE CONSUMER. KOLCRAFT SHALL NOT BE LIABLE FOR ANY INCIDENTAL OR CONSEQUENTIAL DAMAGES FOR BREACH OF ANY EXPRESS OR IMPLIED WARRANTY ON THIS PRODUCT, EXCEPT TO THE EXTENT REQUIRED BY APPLICABLE LAW. ANY IMPLIED WARRANTY OF MERCHANTABILITY OR FITNESS FOR A PARTICULAR PURPOSE ON THIS PRODUCT IS LIMITED TO THE DURATION OF THIS WARRANTY.

Some regions do not allow the exclusion or limitation of warranties set forth above, so the above exclusions may not apply to you. This warranty gives you specific legal rights, and you may have other rights. We sincerely thank you for your purchase of this KOLCRAFT product.

For further information visit [www.kolcraft.com](http://www.kolcraft.com)

## SERVICE HOTLINE

Attention to manufacturing detail and strict quality control ensures that this product meets the highest standards set by Kolcraft Enterprises, Inc. If you encounter any problems or need assistance please call our Customer Service /Warranty Department.

### Please direct any comments or questions to:

Born with Style  
PO Box 789  
Gladesville NSW 1675  
Australia  
Phone: 1300 885 337 or 02 9816 3837  
Email: [warranty@bornwithstyle.com.au](mailto:warranty@bornwithstyle.com.au)

Replacement parts provided by local distributor due to accidental damage or misuse to product will be charged accordingly.

To contact the manufacturer directly:

Kolcraft® Enterprises, Inc. Consumer Service Department  
10832 NC Highway 211East  
Aberdeen, NC 28315  
1-800-453-7673 in U.S. & Canada, 1-910-944-9345 outside U.S. & Canada  
Eastern Standard Time, 8 am-5 pm

## PERSONAL RECORD CARD

Once in a while, we are less than perfect and one of our products reaches a customer with a problem. In most cases, we can solve your problem with replacement parts. Please contact us before you return one of our products to the store. Once a product is returned, it cannot be resold. The materials and the energy used to make it are wasted.

Please fill in the information in the space provided and attach a copy of your purchase receipt. You will need this information to obtain warranty service.

You can find the Model Number and Date of Manufacture on a sticker located on the rear stroller leg.

MODEL NUMBER: \_\_\_\_\_

DATE OF MANUFACTURE: \_\_\_\_\_

DATE OF PURCHASE: \_\_\_\_\_