

Jeep Wrangler® All-Weather Umbrella Stroller Instructions

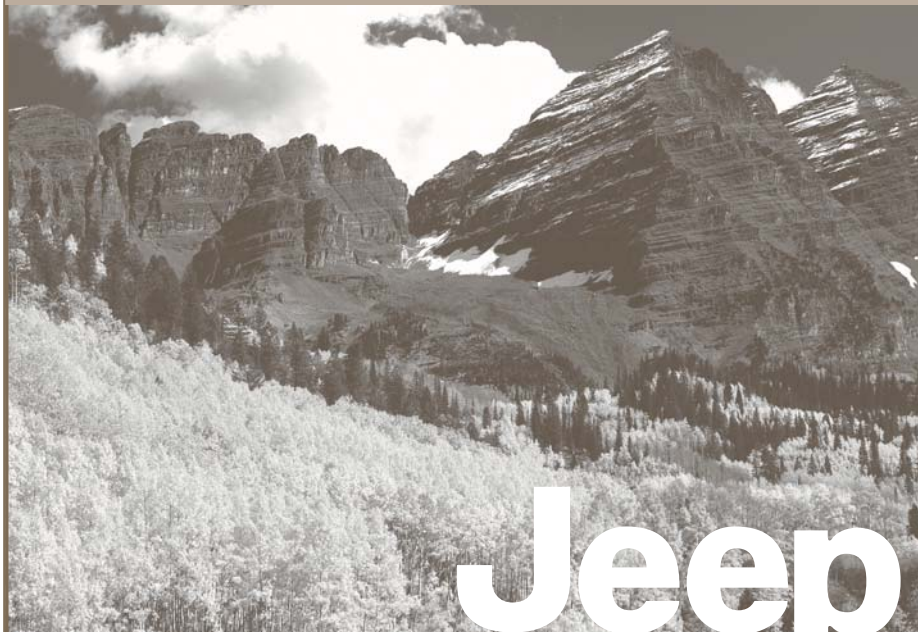

Jeep®

by **Kolcraft**®

 **WARNING**

Your child's safety depends on you. Proper stroller usage cannot be assured unless you follow these instructions.

DO NOT USE STROLLER UNTIL YOU READ AND FOLLOW THE MANUFACTURER'S INSTRUCTIONS.
IMPORTANT SAFETY INFORMATION:

How to Keep Your Child Safe While Using this Stroller

- **NEVER LEAVE YOUR CHILD UNATTENDED WHILE IN STROLLER.** Accidents can happen quickly while your back is turned. You must always keep your child in view while your child is in the stroller, even when sleeping. Do not use this product as a bed. Your child may become tangled in straps or pads and suffocate.
- **Always use restraint system to keep child from standing up or falling out of the stroller. Use this harness at all times.** Do not use product without full 5 point Harness Restraint. Removing the shoulder straps will not adequately restrain child.
- **Always lock the stroller open before allowing your child in or near the stroller.** This prevents injuries caused by stroller collapsing.
- **Only use this stroller with children who weigh less than 35 lbs. (15.88 kg).** Use by larger children may damage the stroller, or cause a hazardous unstable condition to exist.
- **Not recommended for a child under 6 months old.**
- **Only use this stroller when child can sit up unassisted or only use product in recline position (select models).**
- **Always set the wheel brakes when stroller is not moving, especially on an incline.** This prevents the stroller from rolling away.





What to Avoid While Using this Stroller

- **Always balance the weight of the stroller evenly.** To prevent the stroller from becoming unstable or tipping:
 - Do not place parcels or accessory items on the stroller canopy, seat, or over the handle.
 - This stroller is designed for one child only.
 - Do not put more than 3 lbs. (1.36 kg) in the cargo bags or rear storage bag (select models).
 - Do not allow children to play with or hang onto the stroller.
- **Never use this stroller on stairways or escalators.**
- This is **NOT AN EXERCISE STROLLER!** Do not use this product while running, jogging, in-line skating or participating in other athletic activities.

Continued on next page 

- **DO NOT** use any infant car seats with this product. Serious injury could occur.
- Do not allow child to stand on seat or sit on footrest.
- Put on all brakes whenever you park the stroller, especially on an incline. This prevents the stroller from rolling away.
- Always fasten the hood onto the seat back when using the stroller in the reclined position.
- Do not allow children to climb into stroller unassisted. Stroller may tip over and injure child.
- Only use replacement parts supplied by the manufacturer.
- Do not carry extra children or use accessories other than those approved by the vehicle manufacturer.
- The stroller should not be used near an open fire or exposed flame.
- Make sure children are clear of any moving parts if you adjust the stroller, otherwise they may be injured.

Parts List

	 Cup Holder (select models)	 Storage Bag (select models)	 Canopy	 Cargo Bags (2)
Stroller Frame	 Front Wheels (2)	 Rear Wheels (4)	 Axles (2)	 Hub Caps (4)
			 Cotter Pins (2)	 Washers (6)

How to Assemble Your Stroller

To Open Stroller

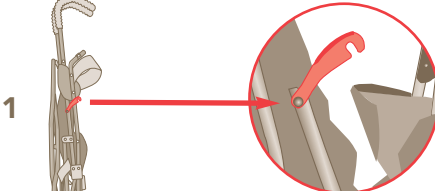
- 

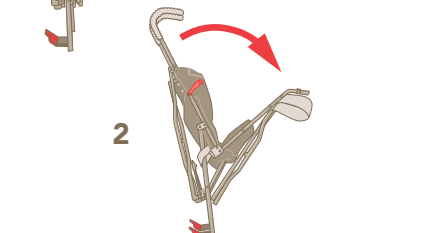
1 Release clip on side of stroller.
- 

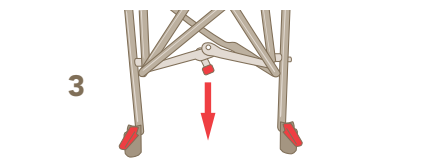
2 Push front of stroller downward.
- 

3 Press down folding bar to lock stroller.

To Assemble Front Wheels

If stroller arrives to you with the wheels off, follow the instructions below.

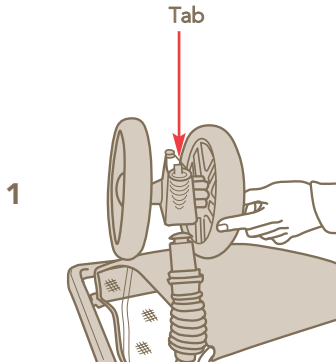

- 1 With tab on front wheel facing away from stroller, place wheel on stroller until it locks onto stroller. Repeat for other front wheel.

NOTE: To remove, squeeze tab and pull wheel off.

To Assemble Rear Wheels

RIGHT REAR WHEEL ASSEMBLY

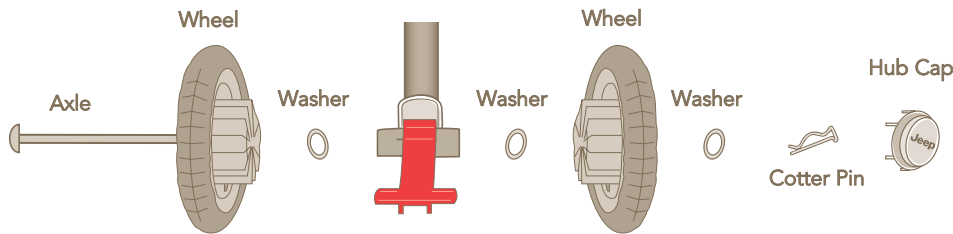

- 1 For the right rear wheel assembly, slide the wheel onto the axle.

- 2 Slide first washer onto axle.

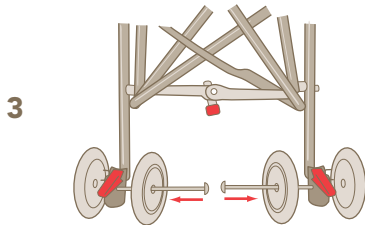

- 3 Insert axle with washer and wheel into right rear wheel assembly as shown. Make sure axle is inserted into rear wheel assembly from the inside wheel.

Continued on next page →

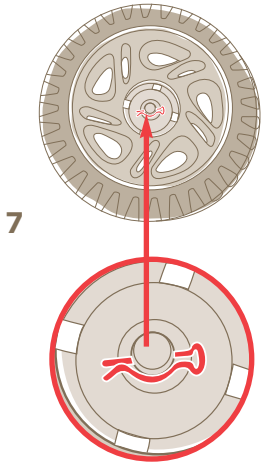
- 4** Slide second washer onto axle.
- 5** Slide other wheel onto axle.
- 6** Slide third washer onto axle.
- 7** Fit straight part of cotter pin through hole on axle.
- 8** Line up tabs in each of the hub caps with slots in the wheel, snap hub caps into place.
- 9** Repeat for left side.

To Attach Cup Holder
(select models)



WARNING

Do not place more than 1 lb (0.45 kg) in this cup holder to avoid tipping!
Do not place hot liquids in this cup holder. Hot liquids can burn your child.

1

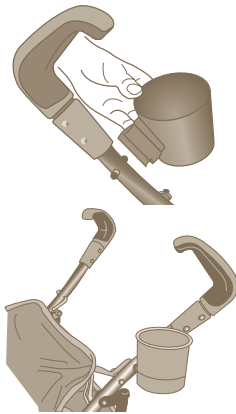

1 Attach cup holder to left handle by lining hole over pin and snap into place.

TO CLEAN: Top rack dishwasher safe.

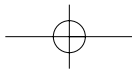

To Attach Canopy

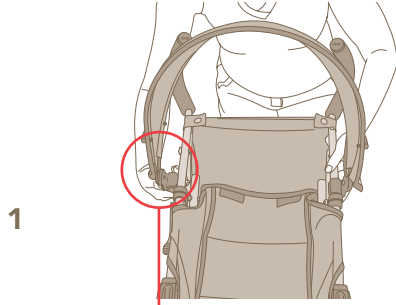

1

- 1 Align canopy connector between stay tab and fabric. Snap on to frame. Repeat for other side.

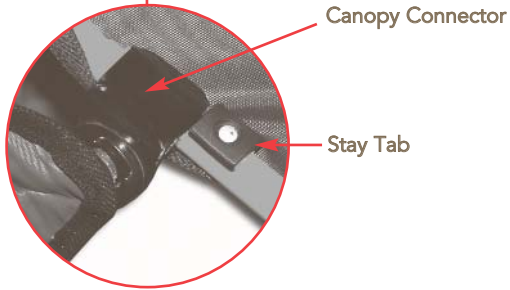

To Attach Cargo Bags

WARNING

Do not put more than 3 lbs (1.36 kg) in this cargo bag.

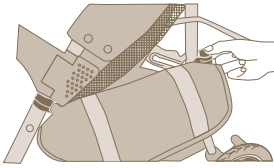

- 1 To attach cargo bags, snap both clips around frame of stroller as shown. Repeat for other side.



How to Properly Use Your New Stroller

To Operate Brakes

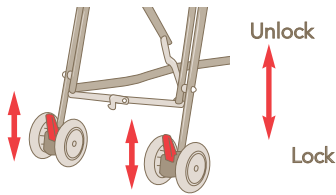

- 1** Push both levers down to lock.
- 2** Pull both levers up to unlock.

To Secure Child In Stroller

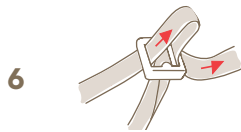
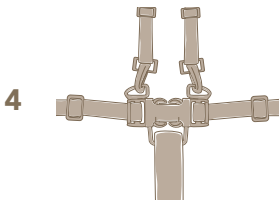
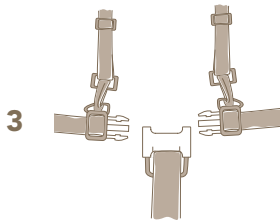

Adjust Restraint System Harness

! WARNING
 Avoid serious injury from falling or sliding out. Always use restraint system. Do not use product without full 5 point Harness Restraint. Removing the shoulder straps will not adequately restrain child.

- 1** Lock foot brake to keep stroller from rolling.
- 2** Place child in stroller.
- 3** Hook shoulder straps to waist belt.
- 4** To fasten restraint system buckles - push together. Be sure both buckles are fastened to secure child safely.
- 5** To unsnap restraint system buckles - press tabs to release.
- 6** For proper fit, adjust shoulder straps and waist band as shown.

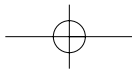



To Recline Seat (select models)

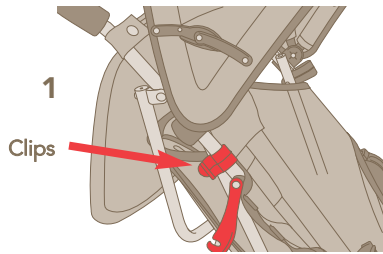

1 Unhook clips from both sides of stroller.

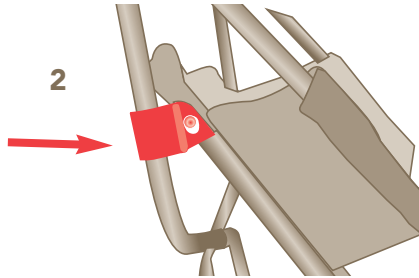

2 Attach clips to lower bar.

To Roll-Up All-Weather Seat Pad

⚠ WARNING
SUFFOCATION HAZARD! Do not use Roll-Up seat pad as a blanket or weather cover.

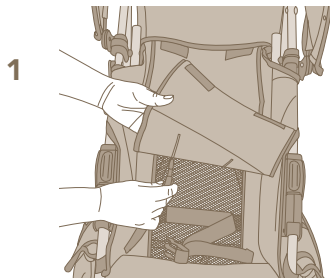

To keep child cool during hot weather, roll up seat pad for better air circulation. During cold weather, roll down.

1 Unthread buckles from seat pad as shown.

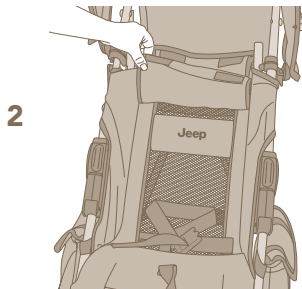

2 Roll up seat pad and fasten Velcro at top of seat as shown.

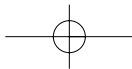

To Adjust Canopy

1



1 To lock canopy open, push up on both side hinges.

2



2 To close, push hinges down.

3 To adjust canopy to block sun or wind, gently push canopy forward to desired position.

To Fold Stroller

1 BEFORE FOLDING: Lock brakes.

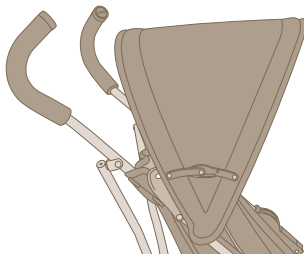

2 Close canopy.

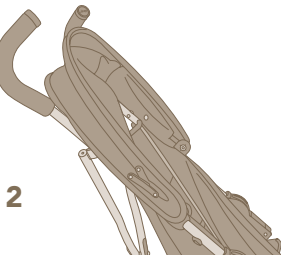

3

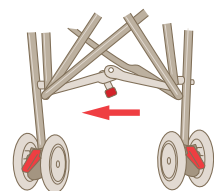

3 Push red lever to the left and lift up.

Continued on next page 

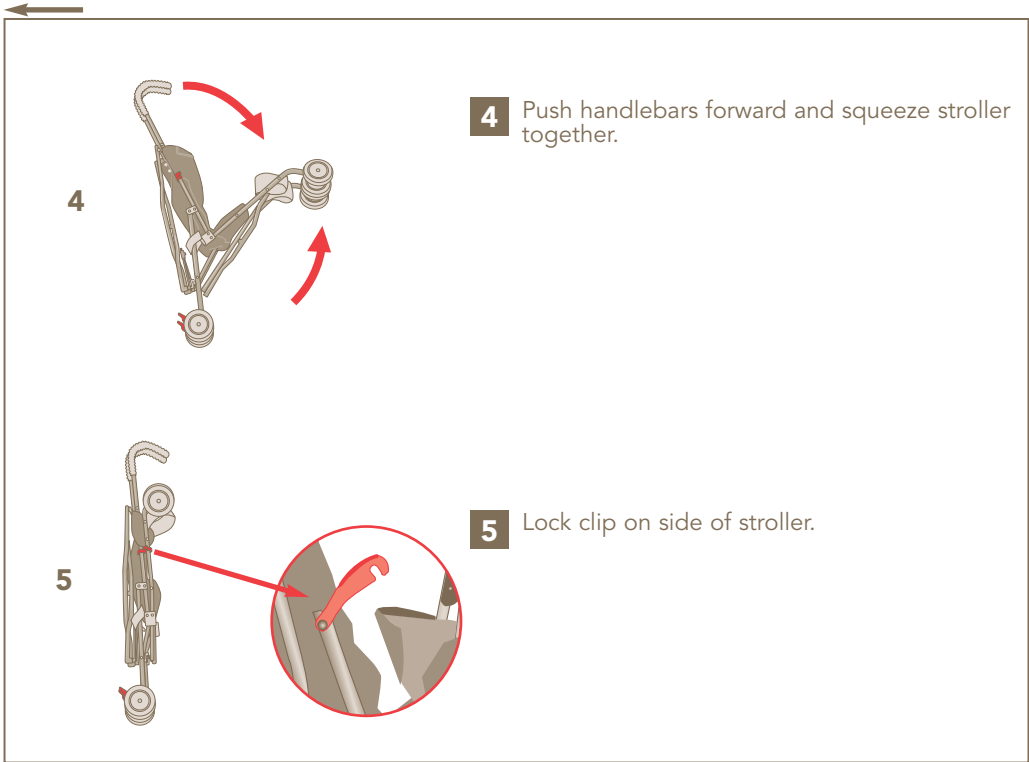

4 Push handlebars forward and squeeze stroller together.

4

5 Lock clip on side of stroller.

5

Care & Maintenance

- Always store your Jeep baby product in a clean dry place. If exposed to damp conditions, leave fully opened and in a warm environment. Clean woven fabric or vinyl parts with mild soap and water solution. Clean metal parts with a damp cloth and wipe dry. Dry wet stroller with a soft cloth to prevent rusting. Storing a damp stroller will encourage mildew to form.
- Do not leave in the boot of a car.
- Avoid exposure to salt water / sea water, as this may encourage the formation of rust. If stroller is used in this environment, completely clean your stroller afterwards to remove sand and salt from mechanisms and wheel assemblies.
- Should parts of your stroller become stiff, squeak or difficult to operate ensure dirt is not the cause. To keep your stroller running smoothly and avoid squeaking wheels use a silicone or graphite based lubricant. It is important to get it into the axle and the wheel assembly. DO NOT over lubricate, as this will encourage the accumulation of dirt.
- When storing stroller, never stack other items on top of it; this may damage the stroller.
- Periodically check for worn parts, loose screws, torn materials or stitching.
- Replace any damaged parts immediately.

Limited Warranty

Jeep® is a registered trademark of DaimlerChrysler Corporation, and is used under license by Kolcraft®. © DaimlerChrysler Corporation 2006

KOLCRAFT® warrants this product to be free of defects in materials and workmanship, as follows: For a period of ONE YEAR from the date of purchase, KOLCRAFT will repair or replace, at its option, the defective product.

REPAIR OR REPLACEMENT AS PROVIDED UNDER THIS WARRANTY IS THE EXCLUSIVE REMEDY OF THE CONSUMER. KOLCRAFT SHALL NOT BE LIABLE FOR ANY INCIDENTAL OR CONSEQUENTIAL DAMAGES FOR BREACH OF ANY EXPRESS OR IMPLIED WARRANTY ON THIS PRODUCT, EXCEPT TO THE EXTENT REQUIRED BY APPLICABLE LAW. ANY IMPLIED WARRANTY OF MERCHANTABILITY OR FITNESS FOR A PARTICULAR PURPOSE ON THIS PRODUCT IS LIMITED TO THE DURATION OF THIS WARRANTY.

Some regions do not allow the exclusion or limitation of warranties set forth above, so the above exclusions may not apply to you. This warranty gives you specific legal rights, and you may have other rights. We sincerely thank you for your purchase of this KOLCRAFT product.

For further information visit www.kolcraft.com

RECALL WEBSITE:
HELP KEEP YOUR CHILD SAFE. Check
www.recall.gov too see if any products you use
with your child or any of your child's toys have
been recalled.

Personal Record Card

Once in a while, we are less than perfect and one of our products reaches a customer with a problem. In most cases, we can solve your problem with replacement parts. Please contact us before you return one of our products to the store. Once a product is returned, it cannot be resold. The materials and the energy used to make it are wasted.

Please fill in the information in the space provided and attach a copy of your purchase receipt. You will need this information to obtain warranty service.

You can find the Model Number and Date of Manufacture on a sticker located on the rear stroller leg.

Please direct any comments, questions or replacement part requests to:

Born with Style
PO Box 789
Gladesville NSW 1675
Australia

Phone: 1300 885 337 or 02 9816 3837

e-mail: warranty@bornwithstyle.com.au

To contact the manufacturer directly:

Kolcraft Enterprises, Inc. Consumer Service Department
10832 NC Highway 211 East
Aberdeen, NC 28315
1-800-453-7673 in U.S. & Canada, 1-910-944-9345 outside U.S. & Canada
Eastern Standard Time, 8 am - 6:45 pm

Model / Style Number: _____

Date of Manufacture: _____

Date of Purchase: _____

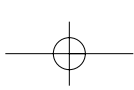
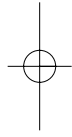
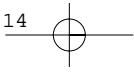

Replacement Parts List

Circle the Part You Need

Replacement parts may look slightly different than what is shown below.

Replacement Parts Order Form

Complete the following form. Your model number and date of manufacture must be included on the form to ensure proper replacement parts.

Model Number _____

Date of Manufacture _____

Total:

Shipping & Handling*: _____ \$20

Total Due: _____

Cheque or money order (in AUS dollar) enclosed (payable to Karlisle's Pty Ltd)

Charge to credit card

Visa Mastercard Bank card

Card#: _____

Expiration Date: ____ / ____

Signature: _____

Post to:

Name _____

Address _____

City, State, Post Code _____

(____) _____
Telephone

Email Address _____