



Arrive...Safe-n-Sound.

BABY SAFETY CAPSULE INFANT RESTRAINT

Series number: 2030/A/2000 AND 2030/A/2004

Child restraint for vehicle use.

INFORMATION FOR BUYERS:

FOR BABIES UP TO 9KG AND 700MM IN LENGTH.

THIS CHILD RESTRAINT MUST BE INSTALLED SO THAT THE BABY
FACES REARWARD AT ALL TIMES.

IMPORTANT: KEEP THIS BOOKLET IN THE PLACE PROVIDED ON THE CHILD RESTRAINT.

Rearward Facing.

For use with children up to 9kg.

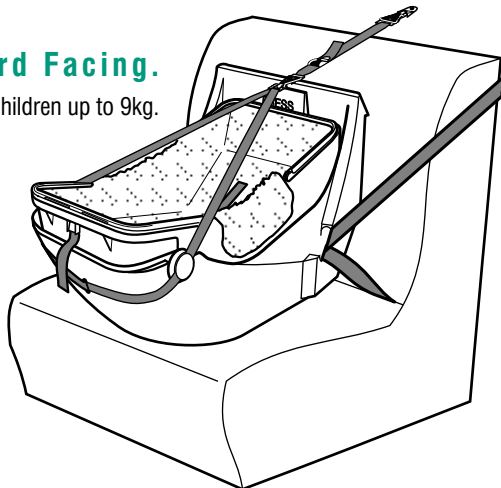



INDEX

FOR BABY USE

WARNINGS	2.	HOW TO INSTALL	9.
INTRODUCTION	3.	HOW TO USE	11.
WHO TO CONTACT	3.	HOW TO CLEAN	17.
HOW TO INSTALL	4.	CARE AND MAINTENANCE	18.
SPECIAL FEATURES	7.	TRAVELLING TIPS	19.
SUITABLE FOR USE	8.	CHECKLIST	19.
WARNINGS	8.	IN CASE OF ACCIDENT	20.



WARNINGS

Use the restraint exactly as shown in the instructions.

Fit the restraint firmly to the car seat and fit the harness firmly to the child.

A loose restraint or harness is dangerous.

Supervision of children is needed because they may be able to undo buckles & adjusters.

DO NOT LEAVE CHILDREN UNATTENDED IN THE CAR.

Do not use seat belt extenders, even if the car seat belt is not long enough to secure the child restraint.

Do not alter or modify this restraint.

Repairs must only be done by the manufacturer or agent.

Do not allow the restraint to come into contact with polishes, oils, bleach and other chemicals.

Destroy the restraint if it has been in a severe crash, even if no damage is visible.

DO NOT USE THIS RESTRAINT WITHOUT THE COVER.

Regularly check the restraint components, straps and other fitments for correct function and condition. Seek prompt repair.

To ensure baby's back is evenly supported do not put more than one nappy on the baby and make sure the nappy is not thickly folded at the back.

DO NOT USE CHILD RESTRAINTS IN A SEATING POSITION WHERE AN AIRBAG IS FITTED. FOLLOW THE CAR MANUFACTURER'S RECOMMENDATIONS.

The restraint should not be purchased or sold as a second hand item. It is recommended not to use child restraints older than 10 years as the protection in an accident may be reduced.

The restraint is not intended to be a substitute baby cot or bed. It is designed to enable safe transportation of children in motor vehicles.

Straps may be damaged by unsecured cargo in a collision. Secure or remove hazardous cargo before using this strap.

THIS RESTRAINT IS NOT SUITABLE FOR USE IN A HATCH-BACK OR WAGON WHERE THE ANCHORAGE STRAP MAY FALL INTO A SPLIT IN THE SEAT BACK.

Protect all webbing from abrasion and cutting by sharp corners and edges.

INTRODUCTION

CAREFULLY READ ALL THE INSTRUCTIONS FOR INSTALLATION. IN THE EVENT OF DOUBT ABOUT THE METHOD OF INSTALLATION, CONSULT BRITAX CHILDCARE OR AGENT OR A CHILD RESTRAINT FITTING STATION AUTHORIZED BY A RELEVANT TRANSPORT AUTHORITY OR, IN NEW ZEALAND, THE AGENT FOR THE VEHICLE.

No child restraint can guarantee absolute protection from injury in every crash. However, to ensure that your child gets all the protection designed into the restraint PLEASE READ AND FOLLOW THESE INSTRUCTIONS EXACTLY and use only **Safe-n-Sound** recommended parts and accessories.

CAUTION: NEVER USE ANY SEAT COVERS OR ACCESSORIES THAT CAUSE THE SHOULDER HARNESS STRAPS TO WIDEN SIDEWAYS WHEN FITTED, AS THE HARNESS WILL NOT RESTRAIN THE CHILD CORRECTLY.

Safe-n-Sound continues to provide care for your children when travelling in motor vehicles with a range of child restraints suitable throughout their childhood.

EASY SELECTOR GUIDE

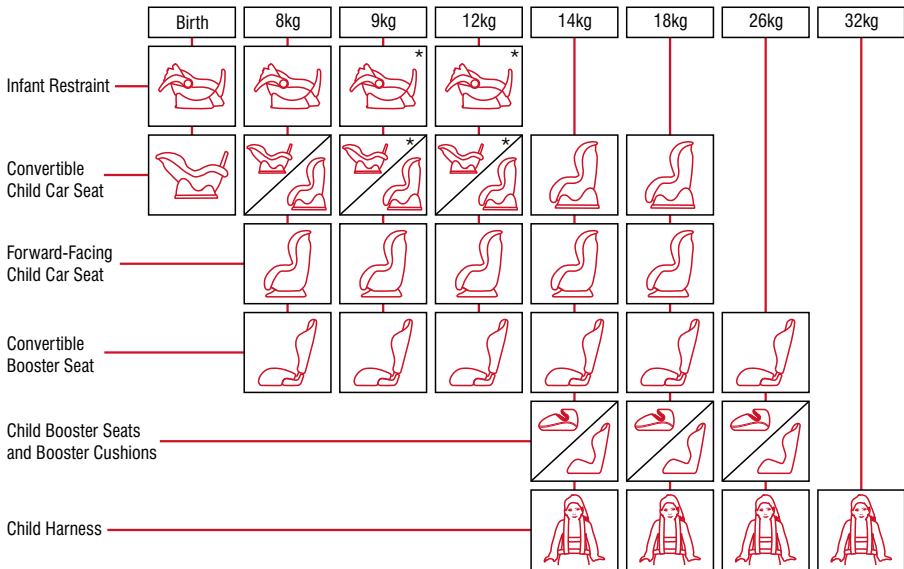

* Refer to Catalogue.



Arrive... Safe-n-Sound.



AUSTRALIA

Britax Childcare Pty. Ltd. A Britax International company. (Incorporated in Victoria) A.C.N 006 773 600 A.B.N 55 006 773 600.

Head office: 99 Derby Road Sunshine, Victoria 3020 Phone: (03) 9288 7288 Fax: (03) 9311 5798

For interstate and country enquiries, Service & Spare Parts (9:30am to 5:00pm E.S.T.) Phone: 1300 303 330

NEW ZEALAND

Britax Childcare NZ Limited. A Britax International company.

PO Box 100-247 Auckland 9 Phone: (09) 443 0102

Fax: (09) 443 0120 Phone toll free: 0800 688 822 (9.30am to 4.00pm)

INTERNATIONAL ENQUIRIES

Contact your Local Distributor.



HOW TO INSTALL

⚠️ WARNINGS

THIS RESTRAINT MUST BE ATTACHED TO A CHILD RESTRAINT ANCHORAGE POINT IN THE CAR. REFER TO CAR OWNER'S HANDBOOK FOR LOCATION OF ANCHORAGE POINTS. REFER TO A CHILD RESTRAINT FITTING STATION IF NO ANCHORAGE POINTS ARE IN THE MOTOR CAR. ONLY USE A 5/16 UNC GRADE 5 BOLT. IF THE BOLT IS NOT THE CORRECT LENGTH THE CAR MANUFACTURER'S HAND BOOK CAN PROVIDE ADVICE ON THE CORRECT LENGTH BOLT.

This restraint must be used in conjunction with a lap or lap-sash seat belt.

Do not alter or modify this restraint, use only recommended parts and accessories.

Protect all webbing from abrasion and cutting by sharp corners and edges.

Consult the vehicle owner's handbook for location of anchorage points and the possible use of spacers. Some vehicles may have an anchor fitting fitted by the vehicle manufacturer. If anchorage points cannot be found refer to car manufacturer or local child restraint fitting station or traffic authority for optimum position of anchorage point and the use of spacers.

Caution: Do not overtighten anchor bolt. Overtightening may fracture or break bolt. Maximum torque is 20 N.m. (14.75 ft.lb.) **Note:** Minimum of five full turns of anchor bolt is required before tightening force is applied. **Do not overtighten.**

IMPORTANT INSTALLATION NOTE:

In some vehicles the anchor fitting in the rear vertical panel can only be installed in one way. Please refer to vehicle owner's handbook or a child restraint fitting station for correct method.

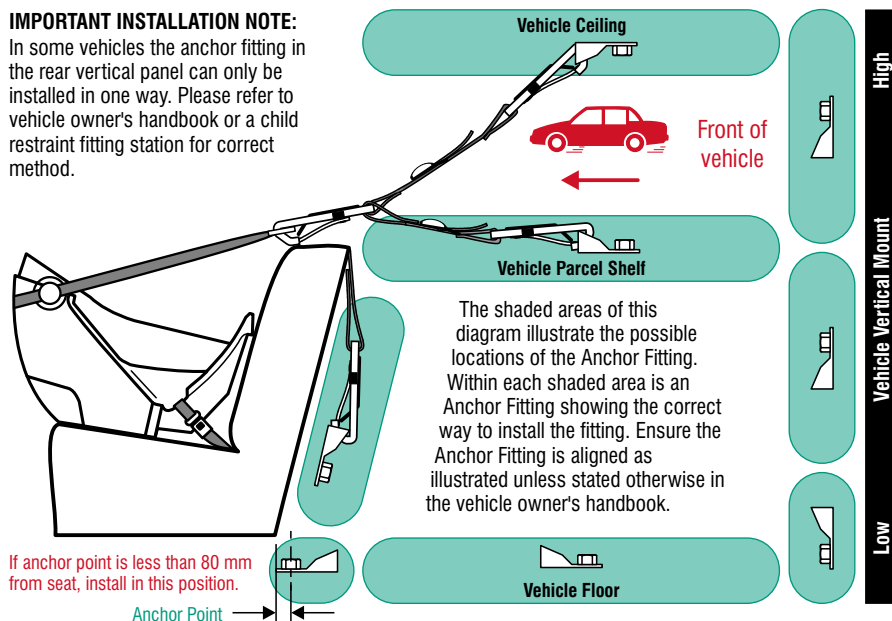

HOW TO INSTALL



ANCHOR FITTING:

If the car is fitted with child restraint anchorage point...

Locate the anchorage point behind the rear seating position to be used. Consult the car owners handbook for the location of the anchorage points. The anchorage point should be directly behind and central to the restraint. Remove thread plug from the parcel shelf, floor/roof, etc. and install anchor bolt and fitting as shown right, ensuring correct direction of anchor fitting as previously illustrated. The spacers provided may need to be used for vehicles with recessed anchorage points.

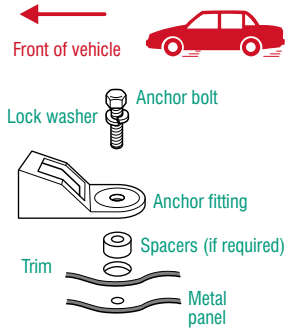

**CAUTION: DO NOT OVERTIGHTEN THE ATTACHMENT BOLT
MAXIMUM TORQUE 20 N.m.**

If the car is not fitted with child restraint anchorage points...

For Sedans only - Drill 9mm diameter hole in the parcel shelf on the centreline of the seating position as shown right. Before drilling the hole, check the underside for accessibility.

Install the anchor bolt as shown below right ensuring the correct direction as shown on page 4. Make sure to use the reinforcing washer and lock washer on the underside of the panel.

For vehicles other than Sedans - In Australia, consult your nearest child restraint fitting station or traffic authority for vehicle inspection to find the best, correct position for the placement of the anchorage point, and for the correct attachment bolt length and use of spacers. In New Zealand, consult the agent for the vehicle.

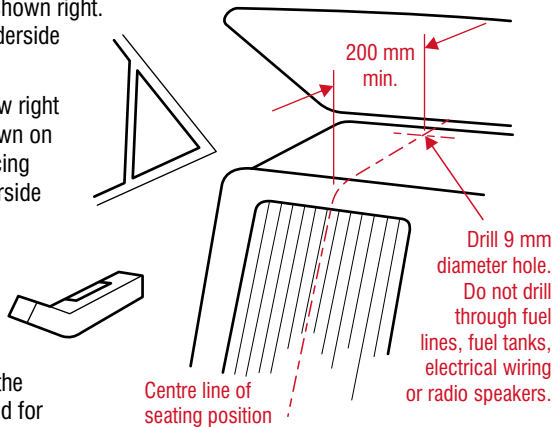

WARNING: Child restraints must not be attached to unsound metal or to wood, or synthetic structures. When drilling 9 mm hole do not drill through fuel lines, fuel tanks, electrical wiring, or radio speakers. Webbing straps must be protected from sharp corners and edges. The anchor fitting must be used only as described above. It must not be hooked onto any other object.

Note to Queensland purchasers: The installation of anchorage points **must be approved** by authorised officers appointed by Queensland Transport. Authorised officers can be sourced from all Queensland Transport Customer Service and Queensland Ambulance Service Centres.

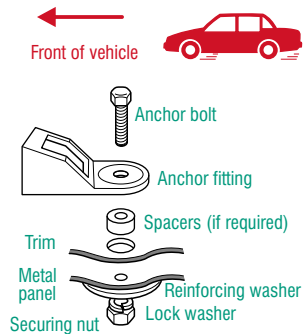



HOW TO INSTALL

UPPER ANCHORAGE STRAP

⚠ IMPORTANT WARNING: THE ATTACHMENT CLIP COVER MUST ALWAYS BE USED AS IT PREVENTS THE RISK OF INCORRECT FITMENT OF THE ATTACHMENT CLIP TO THE ANCHOR FITTING. ALWAYS ENSURE THAT THE ATTACHMENT CLIP IS CORRECTLY ENGAGED TO THE ANCHOR FITTING AND NOT HOOKED OR FITTED TO ANY OTHER OBJECT BEFORE EACH USE OF THE RESTRAINT. THIS IS ESPECIALLY IMPORTANT IN VEHICLES SUCH AS STATION WAGONS, VANS, HATCH BACKS OR VEHICLES WITHOUT A FIXED PARCEL SHELF, SINCE THE ANCHOR POINT IS USUALLY NOT VISIBLE.

The restraint strap & Attachment Clip may be damaged or disconnected by unsecured vehicle contents. To ensure a secure engagement, before each use of the restraint follow this procedure:

- A. Secure or remove any vehicle contents.
- B. Tighten the Upper Anchorage Strap and ensure that strap is not twisted.
- C. Make sure the Attachment Clip is correctly engaged.

The following diagram shows correct method of engaging Attachment Clip to Anchor Fitting.

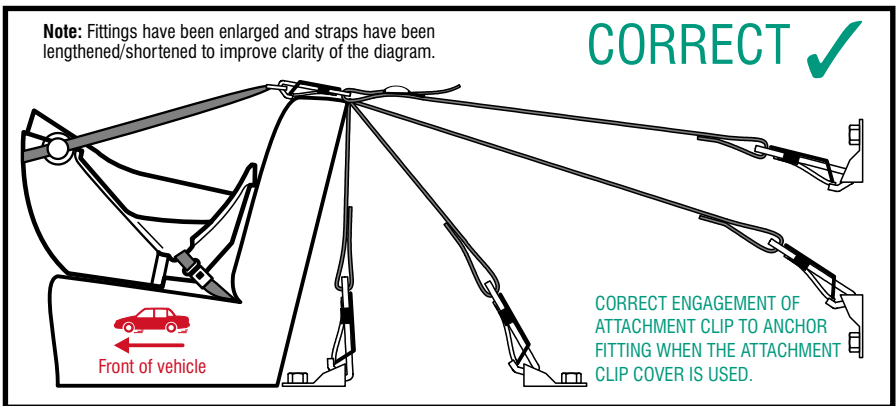

VEHICLE INSTALLATION ACCESSORIES

(Available from retailers of Safe-n-Sound products)

EXTRA ANCHOR KITS: are available if using the restraint in additional vehicles.
Re-order numbers: 0038.

EXTENSION STRAPS: may be required for vehicles without a fixed parcel shelf.
Re-order numbers: 0035 (length 300 mm) 0036 (length 600 mm)

GATED 3-BAR SLIDE: for installation where the seat belt configuration does not firmly hold the child restraint.
Reorder number: 0215.

SPECIAL FEATURES

To be used only in a rearward facing position for a child weighing up to 9 kg and with a length of up to 700mm.

1. Anchor Fitting.
2. Attachment Clip & Cover.
3. Adjustable upper anchorage strap.
4. Adjuster.
5. Upper restraint strap bracket.
6. Upper restraint strap.
7. Press Catch.
8. Harness.
9. Bassinet.
10. Liner.
11. Seat belt.
12. Plastic Hook.
13. Base.
14. Boss cap.
15. Harness Adjuster.
16. Harness Adjustment Strap.

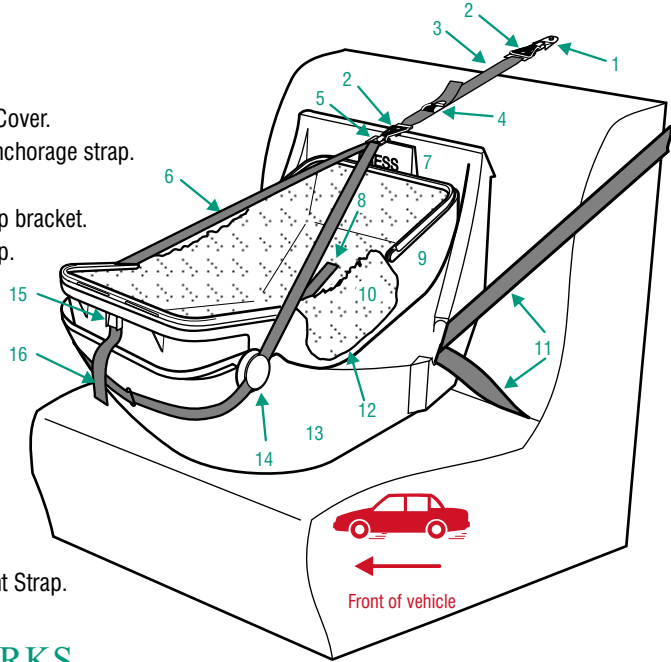

HOW IT WORKS

Why can't you see your baby while travelling? Because having their back to you inside the Baby Safety Capsule is the safest way for your baby to travel in a motor vehicle.

During an accident, the Baby Safety Capsule wants to continue moving forward. The accident sensitive latch disengages during an accident allowing the bassinet to turn about the pivot. With the bassinet turned the impact forces are more uniformly distributed over the whole of the baby's torso and head. The turning bassinet contacts and depresses the energy absorbing bubble, therefore allowing the bassinet to come to rest smoothly without a sudden jolt.

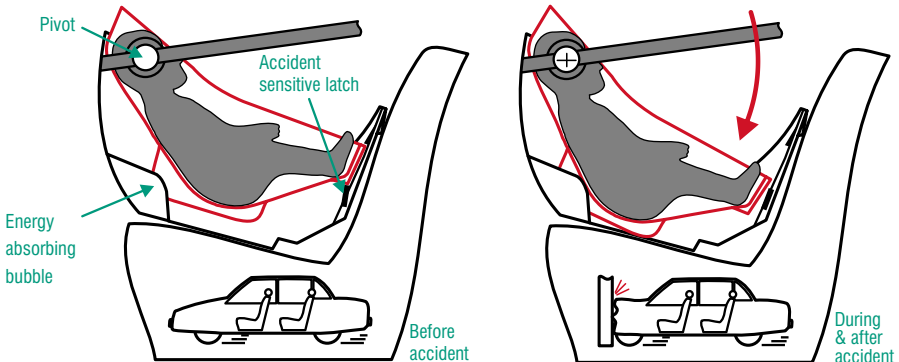



SUITABLE FOR USE

TO BE USED WITH A LAP-SASH OR LAP ONLY SEAT BELT IN THE FRONT OR BACK OF MOST CARS WITH FORWARD-FACING SEATS.

To be used only in a rearward-facing position for a child weighing up to 9kg and with a length of up to 700 mm.

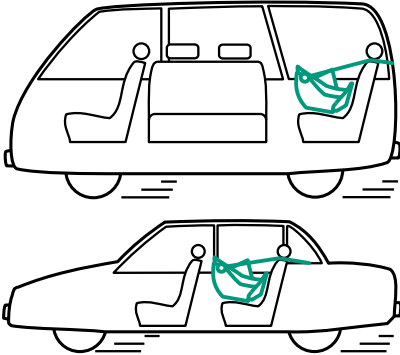

Up to 9 kg maximum



The purchaser should check the measurements between the front of the seat back of the rear seat and all front seats in the car in which the child restraint is intended to be used, to ensure that the space is sufficient.

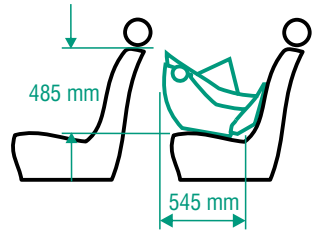

In certain vehicles, where the rear seat is too small, the only position possible for the restraint is the front seat adjusted as rearward as possible.



WARNINGS

THIS TETHER STRAP MUST ALWAYS BE FITTED WHEN THE CHILD RESTRAINT IS USED IN A VEHICLE.

Do not use the restraint without the Upper Anchorage Strap correctly attached.

If your vehicle is not fitted with an anchor point, please contact a Safety Restraint Fitting Station authorised by the relevant State Government Body for correct fitment of the restraint. In New Zealand contact the agent for the vehicle. The upper anchorage strap must be attached to an anchorage point using an extension strap if necessary.

When using the restraint in the front seat, **do not use the rear seat**. The upper anchorage strap will need to pass the rear seating position to attach to an anchorage point.

Do not use on any vehicle seat which faces sideways or rearwards.

DO NOT USE CHILD RESTRAINTS IN A SEATING POSITION WHERE AN AIR BAG IS FITTED. FOLLOW THE CAR MANUFACTURER'S RECOMMENDATIONS.

The Baby Safety Capsule should not contact the back of the front seat as the base may become distorted.

Do not allow the front seat to alter the installed position of the restraint.



HOW TO INSTALL



INSTALLING UPPER ANCHORAGE STRAP

Connect the Upper Anchorage Strap Attachment Clip, at the opposite end of the Adjuster, to the Anchor Fitting.

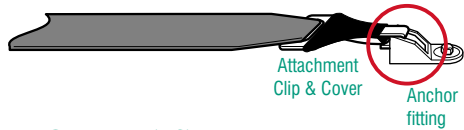

REMOVING BASSINET FROM BASE

- Fold the handles up and grasp with one hand. With the other hand press the catch marked "press".
- With the catch still depressed raise the bassinet past the catch while sliding the bassinet towards the catch end of the base. When the bassinet bosses disengage the base the bassinet is free to be removed.

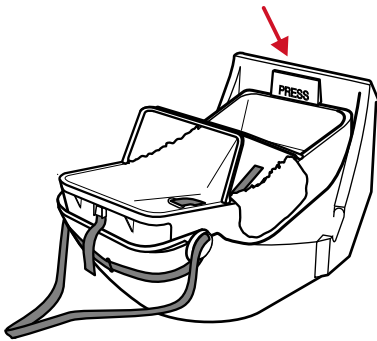

INSTALLING BASE INTO VEHICLE

- Place the base into the vehicle at the selected seating position with the "PRESS" catch end against the seat as shown below. Extend the seat belt to maximum length. For lap-sash seat belt, position the tongue in the middle of the fully extended belt.
- Feed the seat belt tongue through the slot on the side of the base closest to the seat belt anchorage.
- Grasp the seat belt tongue from inside the base, pull through the base and pass up through the slot on the other side.

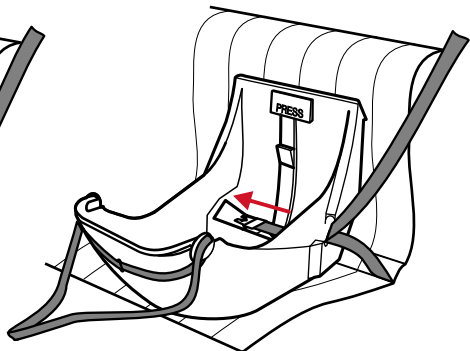
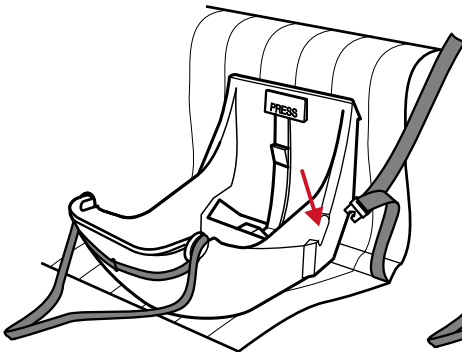



HOW TO INSTALL

D. Reach down through the slot, grasp the seat belt tongue and pull right through.

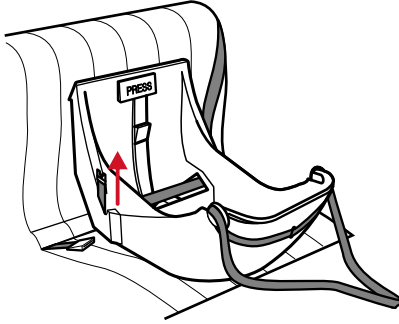

E. Engage the seat belt tongue to the buckle. Adjust the seat belt to hold the base firmly against the seat back.

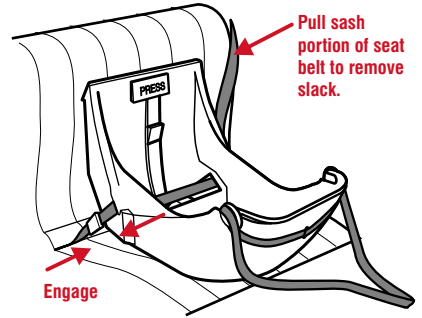

ANGULAR ADJUSTMENT OF CAPSULE

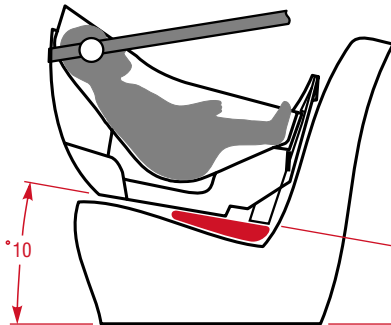

Some vehicle seats have more rearward slope than others. If the angle of the seat causes the baby to be too upright for comfort, the angle may be altered by placing a firm packing between the seat and the underside of the base. (packing can be a firmly rolled up towel or nappy)

Do not remove all of the rearward slope by over packing. Always leave a rearward slope angle of approximately 10 degrees.

HOW TO USE



PLACING BABY IN BASSINET

BABY POSITION: When positioning baby into Bassinet make sure baby's back is fully supported onto the flat section and the baby's nappy area (bottom) is resting in the bottom curvature as shown. **It is recommended that bulky nappies are not used when baby is travelling in the Baby Safety Capsule as they cause incorrect positioning of the baby's back in the bassinet.**

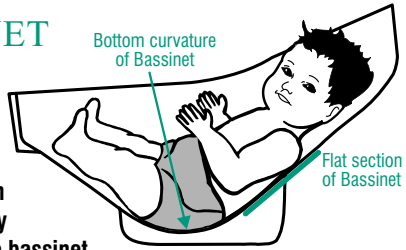

CROTCH STRAP: The Baby Safety Capsule is fitted with three crotch strap positions. Correct location of crotch strap will position baby correctly in bassinet as detailed above and will prevent baby from slipping further into bassinet. As baby grows the crotch strap must be moved to middle or outer slots. Refer to page 15 for correct fitment of crotch strap.

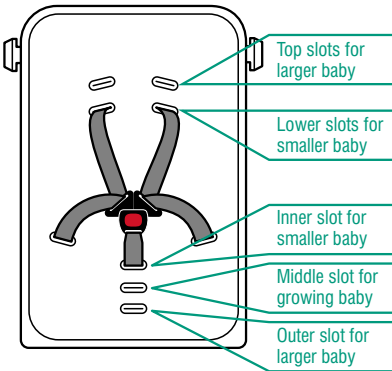

SHOULDER STRAPS: The Baby Safety Capsule is fitted with two shoulder strap positions. As the baby grows the shoulder straps must be moved to the top slots. Refer to page 15 for correct fitment of the harness shoulder straps.

A. Slacken Harness Straps by pressing Harness Adjuster Strap Lock while grasping both Lap Harness Straps and pulling out desired amount of slack. **Release Harness Adjuster Strap Lock when there is enough slack.**

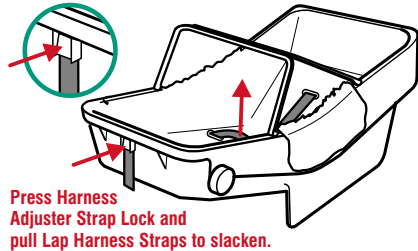

B. Slide the two harness tongues under the elastic side bands. Move the harness buckle away from the boss end of the bassinet.

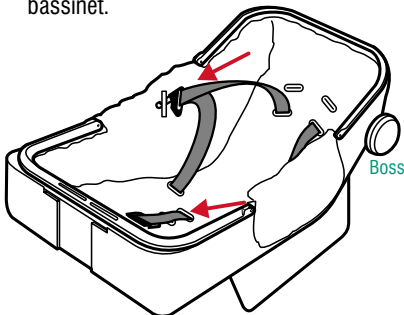

C. Place baby into bassinet lying on its back with head towards boss end. Ensure that baby's arms and legs are free. Make sure baby is dressed to allow Harness Buckle to be pulled up between baby's legs e.g. a jump suit. **Never wrap baby in a blanket before placing in the Baby Safety Capsule.**

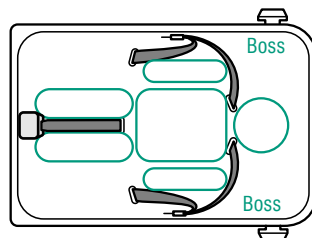



HOW TO USE

SECURING BABY IN BASSINET.

- A. Remove Harness Tongues from elastic side bands. Place each arm through each shoulder strap of the harness. Position the buckle of the crotch strap as shown right.
- B. Fit either harness tongue into the harness buckle followed by the other tongue until a click is heard. Should the second tongue not insert - press the red button and reinsert the tongues. Ensure secure engagement by pulling harness straps.

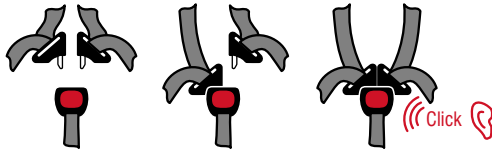
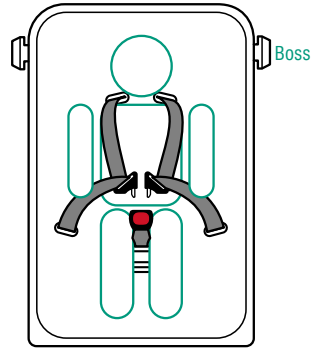

- C. Ensure slack is removed from shoulder harness strap by pulling lap straps then pull the Harness Adjustment Strap to take up the slack in the harness adjusting to a firm but comfortable fit. Make sure that nothing is obstructing the harness straps and that baby's arms and legs are free. Check that slack in straps is minimal. **Do not use the restraint if straps do not tighten and contact your local authorised service agent for repair.**

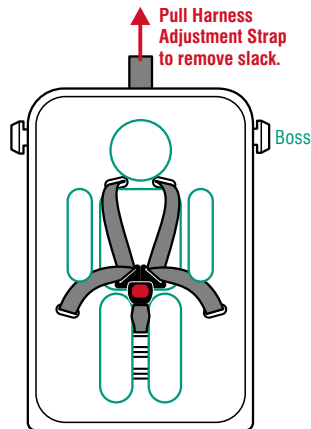
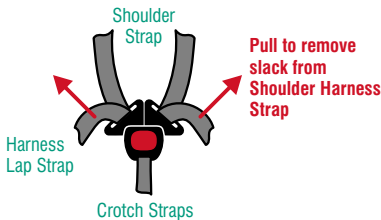

HOW TO USE



PLACING BABY & BASSINET IN BASE

A. Position the bassinet over the top of the base and align the bassinet bosses with the base hooks.

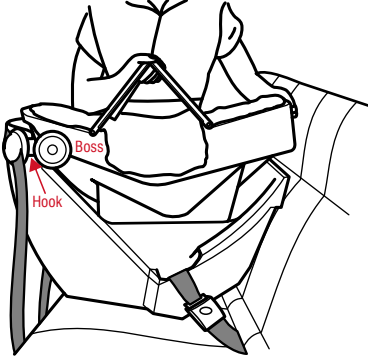

B. Slide the bassinet bosses fully into the base hooks then lower the opposite end of the bassinet.

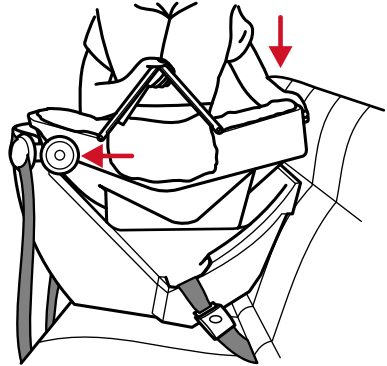

C. Make sure the Harness Adjustment Strap is not caught between Bassinet and Base while lowering Bassinet into Base until the "PRESS" catch snaps into place. Fold both handles down.

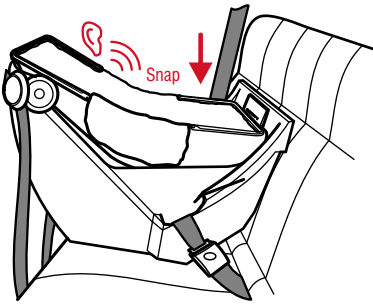

D. Ensure the boss retention caps completely cover the bassinet bosses. Engage upper restraint strap bracket to the upper anchorage strap attachment clip. Ensure that none of the straps are twisted or catching on sharp edges.

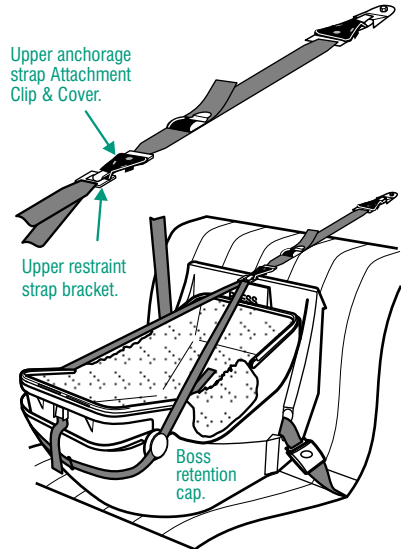

E. Adjust Upper Anchorage Strap by pulling as shown to eliminate any slack in straps.

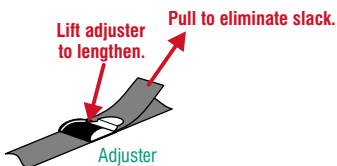

WARNING: THIS TETHER STRAP MUST ALWAYS BE FITTED WHEN THE CHILD RESTRAINT IS USED IN A VEHICLE.



HOW TO USE

REMOVING BABY & BASSINET FROM BASE

- A. Loosen the upper anchorage strap and disengage the upper restraint strap bracket from the upper anchorage strap attachment clip. Ensure that the bracket does not fall on the baby.
- B. Fold handles up and grasp with one hand pressing the catch marked "PRESS" with the other hand.
- C. With the catch depressed raise the bassinet and slide it towards the catch end of the base.
- D. When the bassinet bosses clear the base hooks, raise the bassinet further and remove from vehicle.

REMOVAL OF BABY FROM BASSINET

- A. Press Harness Adjuster Strap Lock while pulling Harness Buckle to slacken the harness.
- B. Press red button on Harness Buckle then both Harness Tongues will be released.
- C. Feed baby's arms through each side of the harness and slide the two Harness Tongues under the elastic side bands. Place buckle between baby's legs and remove baby.

If removing baby from Bassinet while still in the car, first disengage Upper Restraint Strap from the Upper Anchorage Strap ensuring the Upper Restraint Strap Bracket does not fall on the baby.

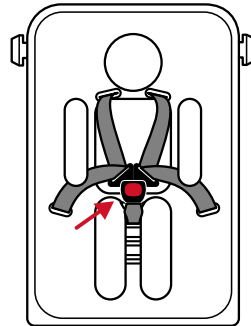

SHOULDER HARNESS & CROTCH STRAP ADJUSTMENT.

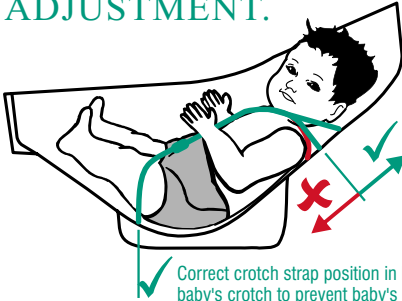

The shoulder straps must be in the slots which are nearest to the child's shoulders, but not lower than the child's shoulders.

Correct crotch strap position in line with baby's crotch to prevent baby's bottom from slipping further into bassinet.

Correct fitment of the harness is very important as it restrains the baby in the restraint. The harness must fit firmly around upper torso of the baby and be positioned so as to leave the baby's arms and legs free.

1. Outer crotch strap slot.
2. Middle crotch strap slot.
3. Inner crotch strap slot.
4. Lap strap slot.
5. Harness tongues & buckle.
6. Shoulder harness strap.
7. Lower shoulder strap slots.
8. Upper shoulder strap slots.

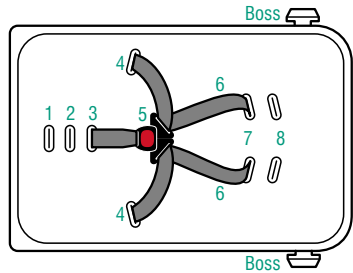

SHOULDER HARNESS STRAPS:

The shoulder straps must be in the slots which are nearest to the child's shoulders, but not lower than the child's shoulders (see diagram above) then the shoulder harness straps must be repositioned to the next slots for a larger baby.

If shoulder harness straps are still below the level of baby's shoulders or your baby weighs more than 9 kg then the restraint should not be used.

FOR LARGER BABY

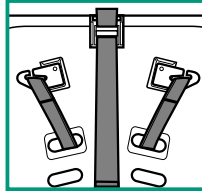

FOR SMALL BABY

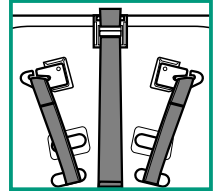

Make sure that no straps are trapped between restraint body and harness shoulder strap.

CROTCH STRAP:

The crotch strap can be moved to the next position to accommodate a growing baby but needs to be in line with the baby's crotch area to securely position baby correctly into the bassinet.

FOR SMALL BABY

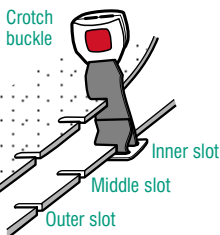

FOR GROWING BABY

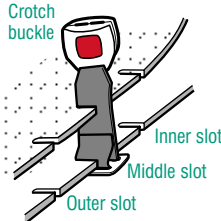

FOR LARGER BABY

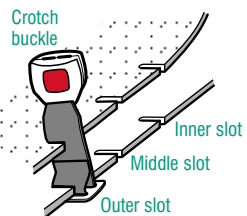

If when straps are positioned in the outer crotch strap slot and in the upper shoulder strap slots and the shoulder harness straps are still below the lever of the baby's shoulders or if your baby weighs more than 9 kg then the restraint should not be used.



HOW TO USE

1. SHOULDER HARNESS ADJUSTMENT

- A. Lift liner at boss end to reveal where shoulder harness straps are threaded through the Bassinet body.

Illustration shows shoulder harness straps positioned for a smaller baby. Liner is cut away for clarity.

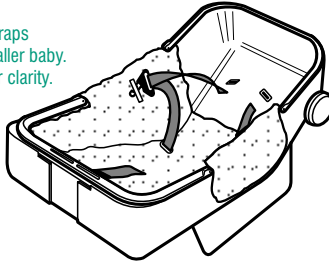

- B. Unthread the strap from the strap connector and push through the lower slot as shown.

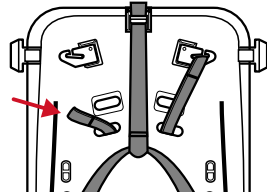

- C. Removing any twists, rethread the strap through upper slot in liner and Bassinet. Re-attach to the strap connector.

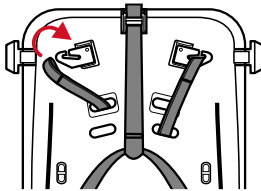

- D. Repeat for other shoulder strap and ensure that both straps are in the same position through the liner and the Bassinet.

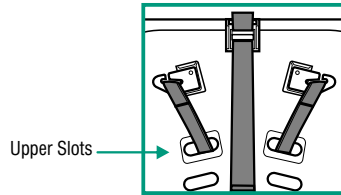

2. ADJUSTMENT OF CROTCH STRAP

- A. Lift liner to reveal crotch strap slot.
- B. From underneath bassinet turn the crotch 3-bar slide and push through slot as shown, then turn and push through the next slot making sure that the crotch 3-bar slide is flat against the body of the Bassinet.

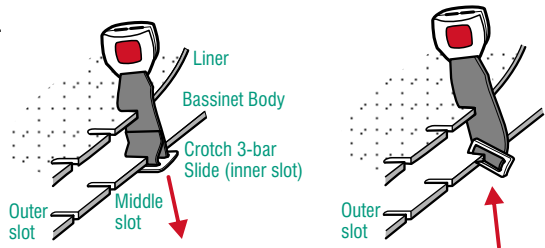

IMPORTANT: When replacing liner, ensure none of the harness straps are twisted and that all straps are secure by pulling each harness strap.



WARNING: Do not use the Baby Safety Capsule with harness shoulder straps set at different heights or fed through mis-matching slots.

HOW TO CLEAN



For baby's comfort and health the Baby Safety Capsule has a flame retardant liner which is removable for cleaning. Cleaning instructions are on the care label attached to the liner. **Washing the liner prior to use will remove excess fluff.** Use only mild soap and water to clean all plastic and metal parts of the Baby Safety Capsule. **Ensure that the inside of the harness buckle is free of foreign matter. Cleaning instructions are on page 18.**

TO REMOVE COVER

- Remove the plastic hooks from both outside ends of the liner.
- Lift bassinet liner at the boss end to reveal 3-bar slides.
- Disconnect shoulder harness straps from strap connector and feed through shoulder slots in both bassinet and liner. Refer to page 16 items 1B & C.
- Feed shoulder harness straps through lap strap slots in liner only.
- Feed crotch buckle 3-bar slide through crotch strap slot in bassinet and liner. Refer to page 16, item 2B.
- Remove liner for cleaning.

TO REPLACE COVER

- Place liner over bassinet ensuring all slots in liner line up with slots in bassinet.
- Ensure that there are no twists in all straps underneath the bassinet.
- Feed shoulder harness straps through lap strap slots in liner.
- Feed shoulder harness straps through shoulder strap slots in liner and then in bassinet. Refer to page 15 for correct shoulder harness position for your baby.

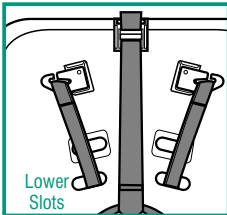

FOR SMALL BABY

Through lower slots, ensuring no other straps are trapped between restraint body and straps.

FOR LARGER BABY

Through upper slots only, ensuring no other straps are trapped between restraint body and straps.

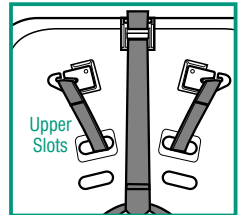

- Feed crotch buckle 3-bar slide through liner and bassinet. Refer to page 15 for correct crotch 3-bar slide position for your baby and adjust if necessary.
- Refit plastic hooks on trim to bassinet as shown right.
- Engage shoulder harness tongues and crotch buckle and pull to check harness is attached.
- Ensure straps are not twisted.

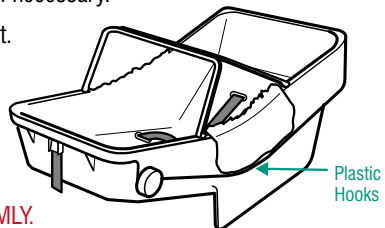

IMPORTANT: When replacing cover, ENSURE THAT ENGAGEMENT OF HARNESS STRAPS BY PULLING FIRMLY.



WARNING: Do not use the Baby Safety Capsule with harness shoulder straps set at different heights or fed through mis-matching slots.



CARE AND MAINTENANCE

REGULAR CARE OF THIS RESTRAINT:

Please check the following items regularly to ensure the safety of your child:

- A. Check the webbing for fraying.
- B. Check that the buckle clicks and is not sluggish or sticky in operation.
- C. Ensure there are no cracks in moulding or the plastic moulding.
- D. Check the harness adjuster is operating and is clamping the webbing.
- E. If any part of the Baby Safety Capsule is cracked or broken, seek repair immediately or replace the Baby Safety Capsule restraint.
- F. Check that the bassinet catch retains the bassinet. Check screws and rivets are firmly in place. If not seek repair.

TO CLEAN HARNESS BUCKLE:

If sticky liquids such as baby formula, fruit juice, etc. get inside your Harness Buckle, it may become sluggish. An indication of a sluggish Harness Buckle is that you cannot hear a click when engaging the Harness Tongues. To restore the Harness Buckle to good working order it needs to be cleaned as follows:

- A. Remove the Harness Buckle from the restraint by disengaging the 3-bar slide as instructed on page 16, item 2B.
- B. Place the Harness Buckle under warm (approx. 40 degrees Celsius) running water as shown below. Let the water run through the mouth of the buckle for five minutes.
- C. Engage and disengage the Harness Tongues and Buckles several times until a strong audible click is heard.

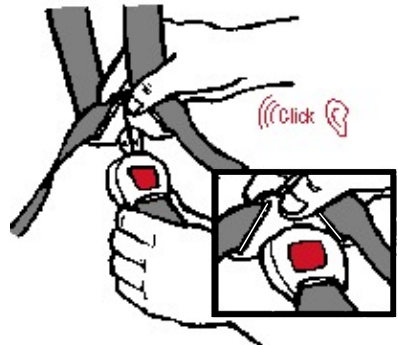
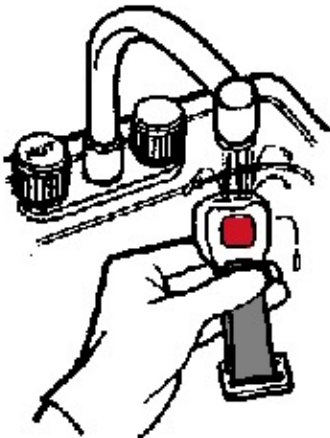

- D. Refit the harness buckle to the restraint with the red button facing out & feeding each 3-bar slide through appropriate slot.
- E. If you still cannot hear a strong audible click after engaging the Harness Tongues & Buckle, then repeat cleaning several times. If the Harness Buckle cannot be returned to its original working condition then contact Safe-n-Sound customer service.



SAFETY

Never hold a baby in arms when riding in a motor vehicle. In this position the baby could be thrown against the dashboard, windscreen or other occupant and suffer serious injury or death.

When riding in a motor vehicle never nurse a baby and use the same seat belt for both of you. In this position the baby or child could be crushed.

Children must be secured in appropriate restraints at all times when the car is in motion. Children travelling unrestrained and standing up in the car are in danger of serious injury or death. Traffic regulations in all states require children to be secured in child restraints or adult seat belts where available.

Plan your trip with frequent comfort stops to reduce stress on babies, young children and driver. Keep the car well ventilated to reduce heat stress. Two car windows should be kept open to maintain a good flow of fresh air if air conditioning is not used.

Never leave babies or toddlers in a stationary car in the sun because of the risk of heat exhaustion.

Ensure babies and toddlers are adequately shaded from direct sunlight through side or rear windows.

Be on guard against carbon monoxide poisoning which can occur through only a slight leak in the exhaust system while travelling in a closed car.

Securely stow all heavy objects, feeding bottles, etc. that could become missiles during an accident and cause injury to any occupant.

CLOTHING/BATHING

Take several changes of clothing and bibs for possible car sickness. Disposable nappies and liners are very handy while travelling. Since it is often warmer in the car, dress the baby in light clothing. When cooler, it is easier to place a blanket over the baby than it is to remove the baby from the restraint and change clothes.

Take a pack containing baby soap, oil, powder, cotton wool, small towel and wet washer in a plastic bag.

FEEDING

Never breast feed a baby while car is in motion. Babies will require extra feeding if travelling in the heat. For bottle fed babies, make up the bottles and refrigerate before leaving home for a day trip. Place in a cool bag and reheat as needed with hot water from a thermos.

Alternatively, bring boiled water in a thermos and pre-measured amounts of baby formula in small containers. Use the water from the thermos to mix with the formula when required. Regardless which method is used, it is always a good plan to carry some boiled water in a sterile container or bottle.

Do not attempt to carry warm milk because germs multiply rapidly in warm milk.

QUESTIONS TO ASK YOURSELF BEFORE STARTING YOUR JOURNEY...	PAGE NUMBER
Have you chosen the correct restraint to fit your vehicle? E.g Will it fit your vehicle seat?	8.
Is the Anchor Fitting installed correctly?	4 & 5.
Do you need an extension strap?	6.
Is the restraint installed in the right position for your baby?	8.
Have you attached the Upper Anchorage Strap to the anchor fitting, removed any twists and tightened the strap? (Do not overtighten.)	6.
Have you installed the seat belt through the correct seat belt slot, removed any twists and tightened the belt?	9 & 10.
Is the Harness adjusted firmly around the child?	12.
What should I do if my buckle doesn't work?	18.
Is the shoulder harness & crotch strap threaded in the correct slots for my baby?	16.
Do boss retention caps completely cover bassinet bosses?	13.
Is the bassinet firmly in the base?	13.



IN CASE OF ACCIDENT

If your restraint has been involved in a severe crash, you should destroy the restraint even if no damage is obvious. Some insurance companies offer vehicle insurance which covers or partially covers the replacement of your child restraint. Contact your insurance company for further details. Your insurance company may require you to keep the child restraint for assessment, **but do not use the child restraint after a severe crash**. To assist you in making an accident insurance claim cut the following statement and include it with your claim.

NOTICE TO INSURANCE COMPANY CHILD RESTRAINT INVOLVED IN AN ACCIDENT

All **Safe-n-Sound** child restraints are manufactured to Australian/New Zealand Standards AS/NZS1754-2004 which require us to advise users of child restraints to "Destroy the entire restraint if it has been in use in a severe crash, even if no damage is obvious". The joint Australian/New Zealand Standards committee CS/85, advise that this statement applies whether a child was in the child restraint or not. A severe crash, we consider as being one where the main body structure of the vehicle is distorted.

There is no method of determining if the restraint has been damaged and we concur with the Australian/New Zealand Standards in recommending destruction of the child restraint.

This notice is to advise you of the requirements of the Australian/New Zealand Standards and our obligation in complying with the standards.

Please assist the owner of this restraint in their claim.

Britax Childcare Pty. Ltd.

(Incorporated in Victoria)
A.B.N 55 006 773 600

Head office and registered address:

99 Derby Road Sunshine Victoria 3020

PO Box 147 Sunshine Victoria 3020

Telephone: 1300 303 330

The **Safe-n-Sound** trade mark is the property of Britax Childcare Pty. Limited-Australia.

The **Britax** trade mark is the property of Britax Excelsior Limited-UK.

Visit the Britax Web Site at <http://www.britax.com.au> or Email us at: custserv@britax.com.au

Series Number: 2030/A/2000 AND 2030/A/2004

We reserve the right to alter this product without notice in our constant endeavour for improvement.

© 1995-2005 Britax Childcare Pty. Ltd. This product is covered by Australian and overseas patent applications. Patents Pending.

Instruction Book Part number: 2108497

