

Toddler Seat to fit

RUNABOUT

Product Reference Guide

Read and follow the instructions and warnings contained within carefully before use. Retain this guide in a safe and easily accessible place for future reference.



Thank you for purchasing a quality VALCO product. Due to our policy of continuous product development, this product is constantly evolving. It is possible that some features or procedures outlined here have changed since this document was written. If you are unsure of any procedure outlined here please contact the store from which you purchased it to obtain the most up to date information, or contact us at cust.service@valco.com.au via the internet.

Identification

Remove the seat from the carton and dispose of any packaging immediately. Your RUNABOUT model has either STANDARD or DELUXE fittings. Examine your model carefully and determine; if there are nylon housings permanently installed on your frame at either side for the front bar, you have DELUXE fitting system.

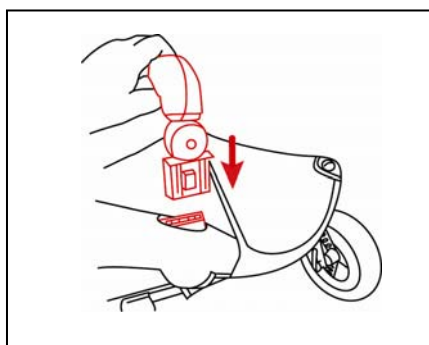

DELUXE FITTING SYSTEM

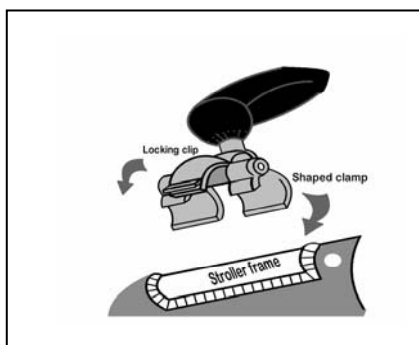

STANDARD FITTING

Installation

Standard System



If they are attached, remove the knob and screw from the "U" clamp riveted to the toddlerseat leg. Your bumper bar not only need not be removed for use with the toddlerseat, but should be adjusted and used as an additional back support.

1. Clamp the toddlerseat legs over the stroller frame in front of the bumper bar.



2. Insert the screw through the "square" hole in the "U" clamp. Be sure that the screw head is firmly seated in the hole.

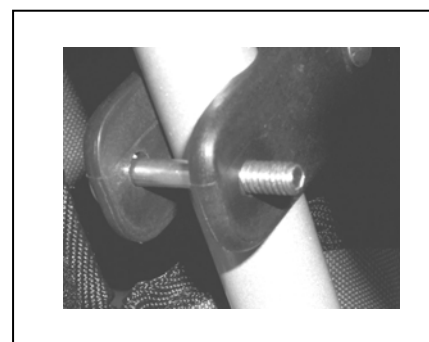

3. Secure with the knob and repeat for the other side.

To remove, simply reverse this process.

IMPORTANT WARNING: Always test that all knobs are securely engaged before use.

Deluxe System

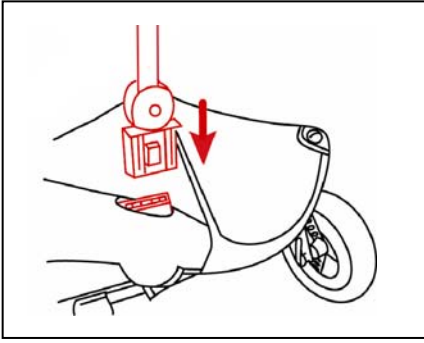

1. Open the flap in the fabric at either side of the stroller.
2. Insert the bar ends into the nylon housing located on either side of the frame. Be sure that the bar is securely engaged in both sides.

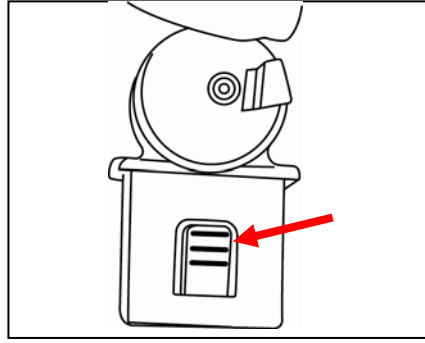

1. **To remove the seat:**
Feeling the side of the nylon housing that sits below the frame at each side (facing inward), locate the release "button."
2. Press the release button inward while simultaneously pushing upward on the bar housing. Repeat for the other side.

Both Systems

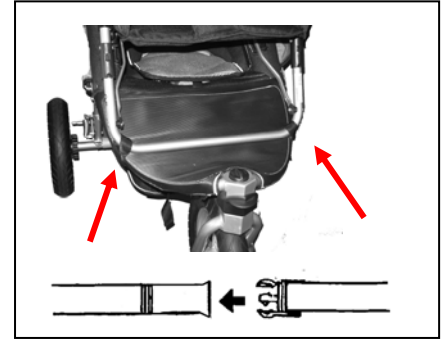

Secure the front legs to the stroller frame by wrapping the 2 side straps around either side of the frame and secure with the buckle.

IMPORTANT WARNING: Always test that all buckles/clamps are securely engaged before use.

Folding your stroller with the seat engaged



1. Placing your foot on the footrest, press in turn each of the two frame release buttons in the plastic housing on the toddlerseat frame.
2. Lift the top half of the seat frame out of the plastic housings.



3. Lift the top half of the seat away from the housing and swing the upper frame legs upward flat against the bottom of the seat.
4. The lower frame will automatically fold down.

Your stroller can now be folded as usual.

Using your harnesses

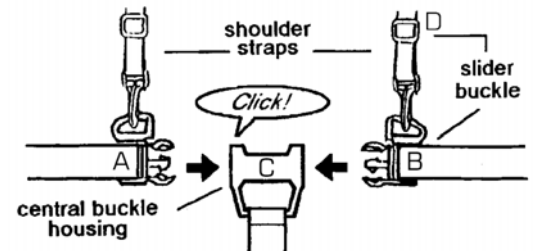

Insert Buckles (A) and (B) into either side of the Buckle Housing (C). Keep inserting until they click into place securely.

Carefully adjust the harness straps to snugly fit your child by adjusting the Sliders (D) located on all Shoulder Straps, Waist Straps and the Crotch Strap.

The harness should be snugly fitted to the baby's body, tight enough so that the baby cannot wriggle itself free of the straps but loose enough so as not to cause the baby any discomfort.

TO OPEN THE HARNESS:

Release the Buckle Prongs – Squeeze on the top and bottom prongs simultaneously and pull apart from the Buckle Housing.

This process may be difficult, as your buckle system has been designed to meet very stringent safety standards to ensure that a child cannot release the harness unaided.



Toddlerseat Canopy



Travel Storage Bag
(single version only)



Sunstopper/Insect
net



WARNINGS

Your child's safety is your responsibility

- **Be** sure to check that all clamps and buckles are securely fixed and in place before use.
- Check all parts for breakage or fatigue before use. Discontinue **immediately** if any part is found to be damaged or broken.
- The **maximum** weight of the toddler in this seat is 20 kg's
- **NEVER** leave your child unattended while in this seat.
- **NEVER** remove your hands from the stroller handle while your child is in this seat.
- **ALWAYS** hold the stroller when your child is climbing into the seat.
- **NEVER** leave the stroller at rest (parked) with a toddler in the seat.
- **NEVER** use this seat if the child is unwilling to sit in it.
- **ALWAYS** be aware of your child's position when sitting in the toddler seat. Excessive leaning to one side or while the stroller is cornering, may cause the unit to become unstable.
- **NEVER** use this seat with a child under 6 months of age and/or is unable to sit up unassisted.
- **NEVER** use this toddler seat with any other brand product.
- Only use this toddler seat with the correct model VALCO ATS Stroller.
- **ALWAYS** ensure that each child is clear of all moving parts when adjusting the stroller.
- **NEVER** leave any child unattended in the stroller.
- **NEVER** use on escalators or stairs.
- When in the stroller each child must **ALWAYS** wear the safety harness, correctly fitted and adjusted, at all times.
- This product is intended for domestic use only. It is not intended for commercial use.

FAILURE TO FOLLOW THE CORRECT ASSEMBLY, USAGE INSTRUCTIONS AND WARNINGS MAY BE HAZARDOUS TO YOUR CHILD AND/OR CAUSE DAMAGE TO THE CONSTRUCTION OF YOUR STROLLER



In Australia/NZ

www.valco.com.au
www.valco.co.nz

In North America

www.valcobaby.com
1 800 610-7850